

Unbrako

Engineering Guide



Socket Products

A comprehensive catalogue of **UNBRAKO®** socket screws and related products

In this catalogue you will find complete information about UNBRAKO socket screws and such related products as shoulder screws, dowel pins, pressure plugs and hex keys. Everything you need to select, specify and order these precision products is at your finger tips except actual prices. Furthermore, all data has been organized to let you find the facts you want with the greatest speed and the least effort.

Wherever possible, all data for a particular product is presented in a two-page spread for your convenience.

This guide refers to products and sizes that may not be manufactured to stock. Please consult an UNBRAKO distributor or UNBRAKO to determine availability.

For prices of stock items, see current UNBRAKO fastener price lists or call your local UNBRAKO fastener distributor.

For non-stock items, consult your UNBRAKO fastener distributor, or contact the UNBRAKO Engineered Fastener Group by phone at +91 - 161 - 3911111 or by fax on +91 - 161 - 2774400 or Internet at <http://www.unbrako.com>.

Commercial and Government Entity (CAGE) Code SFS58

IMPORTANT

The Unbrako Engineering Guide is a **GUIDE** designed to aid product selection, with reference to descriptive and technical data as well as technical discussions for application and use.

The use of precision fasteners in the worldwide market has led to the creation of many standards. These standards specify the fastener requirements: dimensions, material, strength levels, inspection etc. Different standards are the responsibility of various organisations and are not always identical. Unbrako supplies precision fasteners manufactured to Unbrako internal specifications, designed to achieve maximum interchangeability with all standards. Reference Consensus standards referred to in the Unbrako Engineering Guide were current at the time of publication. However, Reference Consensus standards are subject to change by any standards organisation at any time.

Technical data provided in this guide is for reference only and does not constitute certification that products supplied were manufactured to any specific values.

UNBRAKO products are manufactured in accordance with revisions valid at time of manufacture.

Unbrako reserves the right to update or modify its manufacturing specifications without prior notice.

A direct or indirect reference to a consensus standard to represent that a fastener conforms to particular requirements of the consensus standard shall not be construed as a representation that the fastener meets all the requirements of the consensus standard.

The technical discussions referenced in this guide represent typical applications only. The use of information provided is at the sole discretion of the reader. Because applications vary enormously, UNBRAKO does not warrant the scenarios described are appropriate for any specific application. The reader must consider all variables prior to using this information.

Products modified other than by UNBRAKO are not guaranteed and not subject to return.

LIMITED WARRANTY AND EXCLUSIVE REMEDY

Deepak Fasteners Ltd., through its Unbrako Division and associated companies, warrants that these products conform to industry standards specified herein and will be free from defects in materials and workmanship. This warranty is expressly given in lieu of any and all other express or implied warranties, including any implied warranty of merchantability or fitness for a particular purpose, and in lieu of any other obligation on the part of Deepak Fasteners.

Deepak Fasteners will at its option, repair or replace free of charge (excluding all shipping and handling costs) any products which have not been subject to misuse, abuse, or modification and which in its sole determination were not manufactured in compliance with the warranty given above.

Deepak Fasteners makes no representations or warranties, express or implied, that anything imported, made, used, sold, or otherwise provided under any sale agreement is or will be free from infringement of patents or other proprietary rights of any third persons. Nothing in this application, or any agreement, shall be construed as giving rise to any obligation on Deepak Fasteners part to indemnify or hold harmless any Buyer from any liability relating to Buyer's purchase, use, or re-sale of Deepak Fasteners product, or the incorporation of Deepak Fasteners product into another manufactured product.

The remedy provided herein shall be the exclusive remedy for any breach of warranty or any claim arising in any way out of the manufacture, sale or use of these products. In no event shall Deepak Fasteners be liable for consequential, incidental or any other damages of any nature whatsoever except those specifically provided herein for any breach of warranty or any claim arising in any way of the manufacture, sale or use of these products. No other person is authorized by Deepak Fasteners to give any other warranty, written or oral, pertaining to the products.

Note:- This is a Live Document and subject to change. Make sure you have the latest version by downloading from www.unbrako.com

TABLE OF CONTENTS

UNBRAKO® Socket Screw Products



	Page
Quick Selector Guide – Inch	2
Socket Head Cap Screws	4
Alloy Steel and Stainless Steel	4
Low Heads – Alloy Steel	11
Shoulder Screws	12
Alloy Steel	12
Flat Head Socket Screws	14, 16
Alloy Steel and Stainless Steel	14, 16
Button Head Socket Screws	15, 16
Alloy Steel and Stainless Steel	15, 16
Square Head Set Screws	17
Knurled Cup Point	17
Socket Set Screws	18
Alloy Steel and Stainless Steel	18
Pressure Plugs	24
Dryseal Pressure Plugs	24
LEVL-SEAL® Pressure Plugs	25
PTFE/TEFLON*-coated Levl Seal Pressure Plugs	26
Dowel Pins	28
Standard and Pull-Out Type	28
Hexagon Keys	32
Short Arm and Long Arm Wrenches	32
Size Selector Table	33
Thread Conversion chart	34
Metric Table of Contents	35
Metric Socket Head Cap Screws	38
Metric Flat Head Cap Screws	40
Metric Button Head Cap Screws	41
Metric Shoulder Screws	42
Metric Dowel Pins	43
Metric Socket Set Screws	44
Metric Low Head Cap Screws	46
Metric Hexagon Keys and Size Selector Table	47
Metric Tolerances	48
Metric Conversion Chart	50
Technical Section Table of Contents	51

NOTE: The proper tightening of threaded fasteners can have a significant effect on their performance.

Many application problems such as self-loosening and fatigue can be minimized by adequate tightening.



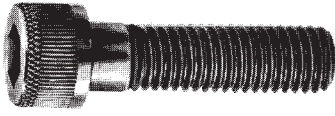
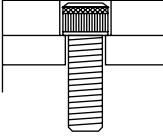
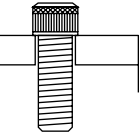
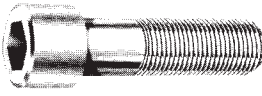
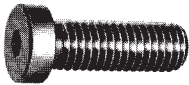

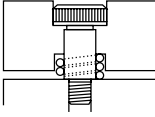
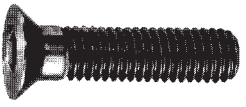
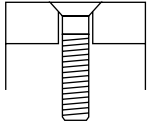
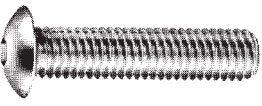



The recommended seating torques listed in the catalog tables serve as guidelines only.

Even when using the recommended seating torques, the induced loads obtained may vary as much as $\pm 25\%$ depending upon the uncontrolled variables such as mating material, lubrication, surface finish, hardness, bolt/joint compliance, etc.

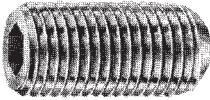
TYPES		APPLICATIONS/FEATURES	PERFORMANCE (See Note 1)			page
			tensile psi (room temp.)	10 ⁷ cycle dynamic fatigue (psi)	operating temperatures (unplated)	
Socket Head Cap Screws 1960 Series Alloy Steel		<p>COUNTERBORED PROTRUDING</p>  <p>Use alloy for maximum tensiles; up to 190,000 psi, highest of any socket cap screw</p>	190,000	20,000	550°F	4-10
			180,000			
Socket Head Cap Screws 1960 Series Stainless Steel		Use stainless for corrosive, cryogenic or elevated temperature environments, hygienic cleanliness.	95,000	30,000	800°F	4-10
Socket Head Cap Screws Low Head Series		Use in parts too thin for standard height heads and where clearance is limited	170,000	20,000	550°F	11
Shoulder Screws		<p>Tool and die industry standards; also replace costly special parts—shafts, pivots, clevis pins, guides, trunnion mountings, linkages, etc.</p> 	heat treat level psi	shear strength in psi	550°F	12-13
			160,000	96,000		
Flat Head Socket Screws Alloy/ Stainless		<p>Uniform, controlled 82° under-head angle for maximum flushness and side wall contact; non-slip hex socket prevents marring of material</p> 	160,000	96,000	550°F	14, 16
					800°F	
Button Head Cap Screws Alloy/ Stainless		<p>Low heads streamline design, use in materials too thin to countersink; also for non-critical loading requiring heat treated screws</p> 	160,000	96,000	550°F	15-16
					800°F	

NOTE 1: Performance data listed are for standard production items only. Non-stock items may vary due to variables in methods of manufacture. It is suggested that the user verify performance on any non-standard parts for critical applications.

INCH QUICK SELECTOR GUIDE

	TYPES	APPLICATIONS/FEATURES	PERFORMANCE (See Note 1)		page	
			hardness	operating temperatures (unplated)		
Square Head Set Screws		Half-dog or self-locking cup points only. Use where maximum tightening torques are required	Rc 45 (min.)	450° F	17	
Socket Set Screws Alloy Steel		Fasten collars, sheaves, gears, knobs on shafts. Locate machine parts. Cone, half-dog, flat, oval, cup and self-locking cup points standard	Rc 45-53	450°F	18-23	
Socket Set Screws Stainless Steel		Use stainless for corrosive, cryogenic or elevated temperatures environments. Plain cup point standard. Other styles on special order	Rb96-Rc33	800°F	18-23	
Pressure Plugs 3/4" Taper Dryseal		Features common to 3/4" and 7/8" tapers: Dryseal threads for positive seal without sealing compound; controlled chamfer for faster starting	Rc 34-40	550°F	24, 26	
			Rb 82 Typical	400°F Brass		
7/8" Taper LEVL-SEAL® Pressure Plug		LEVL-SEAL® plug features: controlled 7/8" tape in 3/4" taper hole seats plug level, flush with surface within 1/2 pitch. LEVL-SEAL plug is an UNBRAKO original	Rc 35-40	550°F	25-27	
			Rb 82 Typical	400°F Brass		
PTFE/TEFLON** Coated		PTFE/TEFLON coated plugs seal at 60% lower seating torques without tape or compound; install faster at lower cost; smaller sizes can be power installed; LEVL-SEAL plug type for 100% flush seating	Rc 35-40	450°F (uncoated)	26-27	
Hex Keys		Tough, ductile, for high torquing; accurate fit in all types socket screws; size marked for quick identity	Rc 47-57	torsional shear in-lb. min. 1.2 to 276.000	32-33	
Dowel Pins (Standard)		Formed ends, controlled heat treat; close tolerances; standard for die work; also used as bearings, gages, precision parts, etc.	core: Rc 50-58	calculated shear psi	28-29	
				150,000		surface 8 micro-inch (max)
Dowel Pins Pull-Out Type		For use in blind holes. Easily removed without special tools. Reusable. Save money. No need for knock-out holes. Same physicals, finish, accuracy and tolerances as standard UNBRAKO dowel pins.	surface: Rc 60 (min.)	150,000	8 micro-inch (max)	30-31

NOTE 1: Performance data listed are for standard production items only. Non-stock items may vary due to variables in methods of manufacture. It is suggested that the user verify performance on any non-standard parts for critical applications.

SOCKET HEAD CAP SCREWS. . . Why Socket Screws? Why UNBRAKO?

The most important reasons for the increasing use of socket head cap screws in industry are safety, reliability and economy. All three reasons are directly traceable to the superior performance of socket screws vs. other fasteners, and that is due to their superior strength and advanced design.

- Reliability, higher pressures, stresses and speeds in today's machines and equipment demand stronger, more reliable joints and stronger, more reliable fasteners to hold them together.
- Rising costs make failure and downtime intolerable. Bigger, more complex units break down more frequently despite every effort to prevent it.
- This is why the reliability of every component has become critical. Components must stay together to function properly, and to keep them together joints must stay tight.
- Joint reliability and safety with maximum strength and fatigue resistance. UNBRAKO socket cap screws offer this to a greater degree than any other threaded fastener you can purchase "off-the-shelf."
- UNBRAKO socket cap screws offer resistance to a greater degree than any other threaded fasteners you can purchase "off-the-shelf."

TENSILE STRENGTH

- U.S. standard alloy steel socket head cap screws are made to strength levels of 180,000 and 170,000 psi to current industry standards. However, UNBRAKO socket cap screws are consistently maintained at 190,000 and 180,000 psi (depending on screw diameter).
- The higher tensile strength of UNBRAKO socket screws can be translated into savings. Using fewer socket screws of the same size can achieve the same clamping force in the joint. A joint requiring twelve 1-3/8" Grade 5 hex heads would need only 7 UNBRAKO socket head cap screws. Use them size for size and there are fewer holes to drill and tap and fewer screws to buy and handle. Smaller diameter socket head cap screws vs. larger hex screws cost less to drill and tap, take less energy to drive, and there is also weight saving.
- The size of the component parts can be reduced since the cylindrical heads of socket screws need less space than hex heads and require no additional wrench space.

FATIGUE STRENGTH

- Joints that are subject to external stress loading are susceptible to fatigue failure. UNBRAKO socket screws have distinct advantages that give you an extra bonus of protection against this hazard.
- Three major factors account for the greater fatigue resistance of UNBRAKO socket screws – design improvements, mechanical properties and closely controlled manufacturing processes.

AUSTENITIC STAINLESS STEEL STANDARD SERIES

UNBRAKO stainless socket screws are made from austenitic stainless steel. UNBRAKO stainless screws offer excellent resistance to rust and corrosion from acids, organic substances, salt solutions and atmospheres. Superior properties attained with stainless steel include retention of a high percentage of tensile strength and good creep resistance up to 800°F. without scaling or oxidation, and good shock and impact resistance to temperatures as low as -300°F.

non-magnetic – Valuable in certain electrical applications. Maximum permeability is 1.2 Can be reduced to 1.02 by bright annealing.

cleanliness – Corrosion resistant characteristics of UNBRAKO screws are useful in chemical, food processing, appliance, paper, textile, packaging and pharmaceutical industries, as well as laboratories, hospitals, etc.

eye-appeal – Bright, non-tarnishing qualities add to appearance and salability of many products; are valuable assets to designers.

Standard processing of UNBRAKO stainless steel socket screws includes a passivation surface treatment which removes any surface contaminations.

SOCKET HEAD CAP SCREWS

Why Socket Screws? . . . Why UNBRAKO ■ "Profile" of Extra Strength

PROFILE OF EXTRA STRENGTH

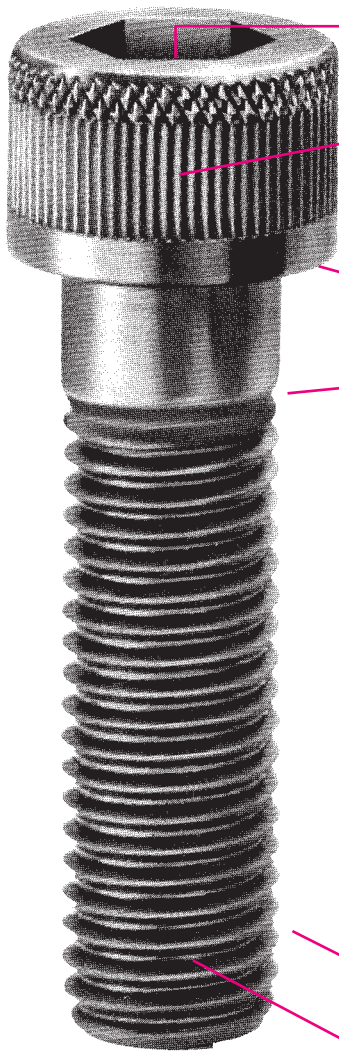

Deep, accurate socket for high torque wrenching. Knurls for easier handling. Marked for easier identification.

Head with increased bearing area for greater loading carrying capacity. Precision forged for symmetrical grain flow, maximum strength.

Elliptical fillet doubles fatigue life at critical head-shank juncture.

"3-R" (radiused-root runout) increases fatigue life in this critical head-shank juncture.

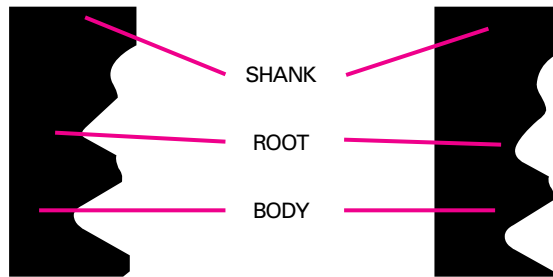

CONVENTIONAL THREAD RUNOUT – Note sharp angle at root where high stress concentration soon develops crack which penetrates into body of the screw.

UNBRAKO "3-R" (RADIUSED ROOT RUNOUT) THREAD – Controlled radius of runout root provides a smooth form that distributes stress and increases fatigue life of thread run-out as a much as 300% in certain sizes.

Fully formed radiused thread increases fatigue life 100% over flat root thread forms.

Controlled heat treatment produces maximum strength without brittleness.

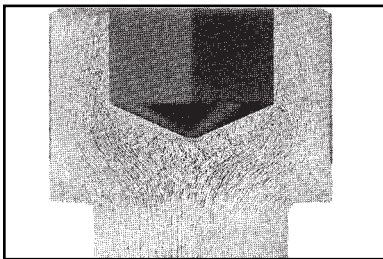

Accurate control of socket depth gives more wrench engagement than other screws, permits full tightening without cracking or reaming the socket, yet provides ample metal in the crucial fillet area for maximum head strength.

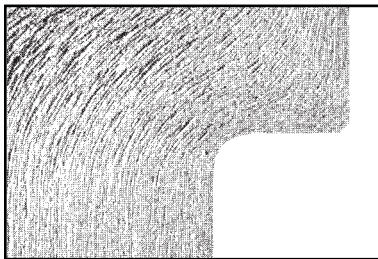

Controlled head forging, uniform grain flow, unbroken flow lines; makes heads stronger; minimizes failure in vital fillet area; adds to fatigue strength.

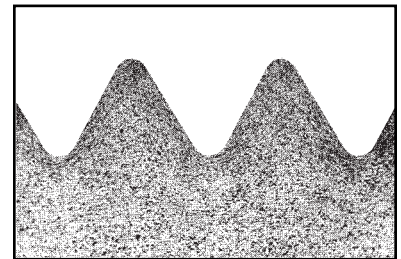

Contour-following flow lines provide extra shear strength in threads, resist stripping and provide high fatigue resistance. The large root radius UNBRAKO socket screw development doubles fatigue life compared to flat root thread forms.

SOCKET HEAD CAP SCREWS ■ 1960 Series ■ Dimensions ■ Mechanical Properties

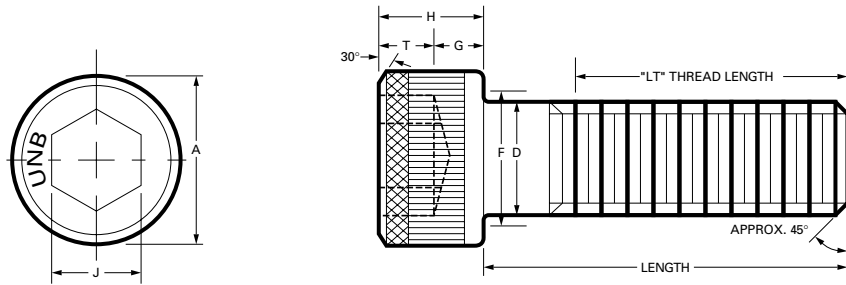

Head markings may vary slightly depending on manufacturing practice. Diamond knurls, UNBRAKO, and UNB are recognized identifications for 1/4" diameter and larger.

DIMENSIONS

nom. size	basic screw dia.	threads per inch		A		D		G	T	H		J	F		LT
		UNRC	UNRF	head diameter		body diameter		min.	min.	head height		nom.	fillet diameter		basic
				max.	min.	max.	min.			max.	min.		max.	min.	
#0	.060	-	80	.096	.091	.060	.0568	.020	.025	.060	.057	.050	.074	.051	.500
#1	.073	64	72	.118	.112	.073	.0695	.025	.031	.073	.070	.062	.087	.061	.625
#2	.086	56	64	.140	.134	.086	.0822	.029	.038	.086	.083	.078	.102	.073	.625
#3	.099	48	56	.161	.154	.099	.0949	.034	.044	.099	.095	.078	.115	.084	.625
#4	.112	40	48	.183	.176	.112	.1075	.038	.051	.112	.108	.094	.130	.094	.750
#5	.125	40	44	.205	.198	.125	.1202	.043	.057	.125	.121	.094	.145	.107	.750
#6	.138	32	40	.226	.218	.138	.1329	.047	.064	.138	.134	.109	.158	.116	.750
#8	.164	32	36	.270	.262	.164	.1585	.056	.077	.164	.159	.141	.188	.142	.875
#10	.190	24	32	.312	.303	.190	.1840	.065	.090	.190	.185	.156	.218	.160	.875
1/4	.250	20	28	.375	.365	.250	.2435	.095	.120	.250	.244	.188	.278	.215	1.000
5/16	.312	18	24	.469	.457	.3125	.3053	.119	.151	.312	.306	.250	.347	.273	1.125
3/8	.375	16	24	.562	.550	.375	.3678	.143	.182	.375	.368	.312	.415	.331	1.250
7/16	.437	14	20	.656	.642	.4375	.4294	.166	.213	.437	.430	.375	.484	.388	1.375
1/2	.500	13	20	.750	.735	.500	.4919	.190	.245	.500	.492	.375	.552	.446	1.500
9/16	.562	12	18	.843	.827	.5625	.5538	.214	.265	.562	.554	.438	.6185	.525	1.625
5/8	.625	11	18	.938	.921	.625	.6163	.238	.307	.625	.616	.500	.689	.562	1.750
3/4	.750	10	16	1.125	1.107	.750	.7406	.285	.370	.750	.740	.625	.828	.681	2.000
7/8	.875	9	14	1.312	1.293	.875	.8647	.333	.432	.875	.864	.750	.963	.798	2.250
1	1.000	8	12	1.500	1.479	1.000	.9886	.380	.495	1.000	.988	.750	1.100	.914	2.500
1	1.000	-	14*	1.500	1.479	1.000	.9886	.380	.495	1.000	.988	.750	1.100	.914	2.500
1 1/8	1.125	7	12	1.688	1.665	1.125	1.1086	.428	.557	1.125	1.111	.875	1.235	1.023	2.812
1 1/4	1.250	7	12	1.875	1.852	1.250	1.2336	.475	.620	1.250	1.236	.875	1.370	1.148	3.125
1 3/8	1.375	6	12	2.062	2.038	1.375	1.3568	.523	.682	1.375	1.360	1.000	1.505	1.256	3.437
1 1/2	1.500	6	12	2.250	2.224	1.500	1.4818	.570	.745	1.500	1.485	1.000	1.640	1.381	3.750
1 3/4	1.750	5	12	2.625	2.597	1.750	1.7295	.665	.870	1.750	1.734	1.250	1.910	1.609	4.375
2	2.000	4 1/2	12	3.000	2.970	2.000	1.9780	.760	.995	2.000	1.983	1.500	2.180	1.843	5.000
2 1/4	2.250	4 1/2	12	3.375	3.344	2.250	2.2280	.855	1.120	2.250	2.232	1.750	2.450	2.093	5.625
2 1/2	2.500	4	12	3.750	3.717	2.500	2.4762	.950	1.245	2.500	2.481	1.750	2.720	2.324	6.250
2 3/4	2.750	4	12	4.125	4.090	2.750	2.7262	1.045	1.370	2.750	2.730	2.000	2.990	2.574	6.875
3	3.000	4	12	4.500	4.464	3.000	2.9762	1.140	1.495	3.000	2.979	2.250	3.260	2.824	7.500

Performance data listed are for standard production items only. Non-stock items may vary due to variables in methods of manufacture. It is suggested that the user verify performance on any non-standard parts for critical applications.

* 1-14 is UNRS (special) standard thread form.

SOCKET HEAD CAP SCREWS

1960 Series ■ Dimensions ■ Mechanical Properties ■ Application Data

NOTES

Material: ASTM A574 – alloy steel
ASTM F837 – stainless steel

Dimensions: ANSI/ASME B18.3

Hardness: Alloy Steel – Rc 38-43
Stainless Steel – Rb 80 – Rc 33

Concentricity: Body to head O.D. – within 2% of body diameter T.I.R. or .006 T.I.R. whichever is greater. Body to hex socket – (sizes through 1/2") – within 3% of body diameter T.I.R. or .005 T.I.R. whichever is greater; (sizes over 1/2" – within 6% of body diameter).

The plane of the bearing surface shall be perpendicular to the axis of the screw within a maximum deviation of 1°.

For body and grip lengths see pages 8 and 9.

Thread Class: #0 through 1" dia. – 3A; over 1" dia. – 2A.

Typical values for test specimens:

Alloy Steel	Stainless Steel
10% min.	10% min.
35% min.	30% min.

Elongation in 2 inches:

Reduction of area:

MECHANICAL PROPERTIES

nom. size	ALLOY STEEL							STAINLESS STEEL						
	tensile strength pounds		minimum tensile strength psi min.	minimum yield strength psi min.	single shear strength of body lbs. min.	recommended seating torque* in-lbs		tensile strength pounds		minimum tensile strength	minimum yield strength	single shear strength	recommended seating torque* in-lbs	
	UNRC	UNRF				UNRC	UNRF	plain	plain				UNRC	UNRF
			plain	plain	plain					plain				
#0	–	342	190,000	170,000	320	–	3	–	171	95,000	30,000	130	–	1.3
#1	499	528	190,000	170,000	475	5	5	250	264	95,000	30,000	190	2.0	2.3
#2	702	749	190,000	170,000	660	7	8	352	374	95,000	30,000	260	3.8	4
#3	925	994	190,000	170,000	875	12	13	463	497	95,000	30,000	350	5.7	6
#4	1,150	1,260	190,000	170,000	1,120	18	19	574	628	95,000	30,000	440	8.0	9
#5	1,510	1,580	190,000	170,000	1,400	24	25	756	789	95,000	30,000	550	12	14
#6	1,730	1,930	190,000	170,000	1,700	34	36	864	964	95,000	30,000	670	15	17
#8	2,660	2,800	190,000	170,000	2,400	59	60	1,330	1,400	95,000	30,000	850	28	29
#10	3,330	3,800	190,000	170,000	3,225	77	91	1,660	1,900	95,000	30,000	1,280	40	45
1/4	6,050	6,910	190,000	170,000	5,600	200	240	3,020	3,460	95,000	30,000	2,200	95	110
5/16	9,960	11,000	190,000	170,000	8,750	425	475	4,980	5,510	95,000	30,000	3,450	170	190
3/8	14,700	16,700	190,000	170,000	12,600	750	850	7,360	8,350	95,000	30,000	4,470	300	345
7/16	20,200	22,600	190,000	170,000	17,100	1,200	1,350	10,100	11,300	95,000	30,000	6,760	485	545
1/2	27,000	30,400	190,000	170,000	22,350	1,850	2,150	13,500	15,200	95,000	30,000	8,840	750	850
9/16	32,800	36,500	180,000	155,000	28,300	2,500	2,700	17,300	19,300	95,000	30,000	11,200	920	1,050
5/8	40,700	46,100	180,000	155,000	34,950	3,400	3,820	21,500	24,300	95,000	30,000	13,800	1,270	1,450
3/4	60,200	67,100	180,000	155,000	47,700	6,000	6,800	31,700	35,400	95,000	30,000	19,850	2,260	2,520
7/8	83,100	91,700	180,000	155,000	64,000	8,400	9,120	44,000	48,400	95,000	30,000	27,100	3,790	4,180
1	109,000	119,000	180,000	155,000	84,800	12,500	13,200	57,600	63,000	95,000	30,000	35,300	5,690	6,230
1	–	122,000	180,000	155,000	107,000	–	13,900							
1-1/8	137,000	154,000	180,000	155,000	107,000	14,900	16,600							
1-1/4	175,000	193,000	180,000	155,000	132,500	25,000	27,000							
1-3/8	208,000	237,000	180,000	155,000	160,000	33,000	35,000							
1-1/2	253,000	285,000	180,000	155,000	190,500	43,500	47,000							
1-3/4	342,000	394,000	180,000	155,000	259,500	71,500	82,500							
2	450,000	521,000	180,000	155,000	339,000	108,000	125,000							
2-1/4	585,000	664,000	180,000	155,000	429,000	155,000	186,000							
2-1/2	720,000	828,000	180,000	155,000	530,000	215,000	248,000							
2-3/4	888,000	1,006,000	180,000	155,000	641,000	290,000	330,000							
3	1,074,000	1,204,000	180,000	155,000	763,000	375,000	430,000							

*Seating torques for alloy steel calculated in accordance with VDI 2230, "Systematic Calculation of High Duty Bolted Joints," to induce approximately 120,000 PSI in the screw threads through 0.500-inch diameter, and 115,000 PSI over 0.500-inch diameter. Seating torques for stainless steel are calculated to induce approximately 40,000 PSI stress. Values are for plain screws. For cadmium plated screws, multiply recommended seating torque by .75; for zinc plated screws multiply by 1.40. See note, page 1.

See Technical Guidelines section for additional information on torques, installation, and hole preparation.

SOCKET HEAD CAP SCREWS ■ 1960 Series ■ Body and Grip Lengths

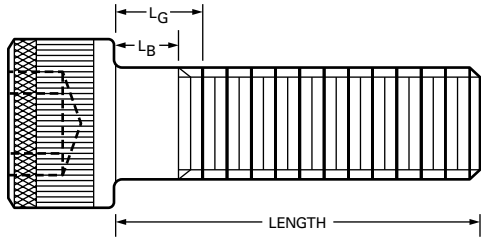

LENGTH TOLERANCES

diameter	up to 1" incl.	over 1" to 2 1/2" incl.	over 2 1/2" to 6" incl.	over 6"
#0 thru 3/8 incl.	-.03	-.04	-.06	-.12
7/16 to 3/4 incl.	-.03	-.06	-.08	-.12
7/8 to 1-1/2 incl.	-.05	-.10	-.14	-.20
over 1 1/2		-.18	-.20	-.24

BODY and GRIP LENGTHS

length	#0		#1		#2		#3		#4		#5		#6		#8		#10		1/4		
	L_G	L_B	L_G	L_B	L_G	L_B	L_G	L_B	L_G	L_B	L_G	L_B	L_G	L_B	L_G	L_B	L_G	L_B	L_G	L_B	
3/4	.250	.187																			
7/8	.250	.187	.250	.172	.250	.161	.250	.146													
1	.500	.437	.250	.172	.250	.161	.250	.146	.250	.125	.250	.125									
1 1/4	.750	.687	.625	.547	.625	.536	.625	.521	.250	.125	.250	.125	.500	.344	.375	.219	.375	.167			
1 1/2			.875	.797	.875	.786	.875	.771	.750	.625	.750	.625	.500	.344	.375	.219	.375	.167	.500	.250	
1 3/4					1.125	1.036	1.125	1.021	.750	.625	.750	.625	1.000	.844	.875	.719	.875	.667	.500	.250	
2							1.375	1.271	1.250	1.125	1.250	1.125	1.000	.844	.875	.719	.875	.667	1.000	.750	
2 1/4											1.250	1.125	1.500	1.344	1.375	1.219	1.375	1.167	1.000	.750	
2 1/2											1.750	1.625	1.500	1.344	1.375	1.219	1.375	1.167	1.500	1.250	
2 3/4													2.000	1.844	1.875	1.719	1.875	1.667	1.500	1.250	
3															1.875	1.719	1.875	1.667	2.000	1.750	
3 1/4															2.375	2.219	2.375	2.167	2.000	1.750	
3 1/2																	2.375	2.167	2.500	2.250	
3 3/4																	2.875	2.667	2.500	2.250	
4																			3.000	2.750	
4 1/4																				3.000	2.750
4 1/2																				3.500	3.250
4 3/4																				3.500	3.250
5																				4.000	3.750
5 1/4																				4.000	3.750
5 1/2																					
5 3/4																					
6																					
6 1/4																					
6 1/2																					
6 3/4																					
7																					
7 1/4																					
7 1/2																					
7 3/4																					
8																					
8 1/2																					
9																					
9 1/2																					
10																					
11																					
12																					
13																					
14																					
15																					
16																					
17																					
18																					
19																					
20																					

SOCKET HEAD CAP SCREWS

1960 Series ■ Body and Grip Lengths

L_G is the maximum grip length and is the distance from the bearing surface to the first complete thread.

L_B is the minimum body length and is the length of the unthreaded cylindrical portion of the shank.

Thread length for the sizes up to and including 1" diameter shall be controlled by the grip length and body length as shown in the table.

For sizes larger than 1" the minimum complete thread length shall be equal to the basic thread length, and the

total thread length including imperfect threads shall be basic thread length plus five pitches. Lengths too short to apply formula shall be threaded to head. Complete threads shall extend within two pitches of the head for lengths above the heavy line on sizes up to and including 5/8" diameter. Larger diameters shall be threaded as close to the head as practicable.

Screws of longer lengths than those tabulated shall have a thread length conforming to the formula for sizes larger than 1".

	5/16		3/8		7/16		1/2		9/16		5/8		3/4		7/8		1	
	L _G	L _B	L _G	L _B	L _G	L _B	L _G	L _B	L _G	L _B	L _G	L _B	L _G	L _B	L _G	L _B	L _G	L _B
	.625	.347	.500	.187														
	.625	.347	.500	.187	.625	.268												
	1.125	.847	1.000	.687	.625	.268	.750	.365										
	1.125	.847	1.000	.687	1.125	.768	.750	.365	.875	.458	.750	.295						
	1.625	1.187	1.500	1.187	1.125	.768	.750	.365	.875	.458	.750	.295						
	1.625	1.347	1.500	1.187	1.625	1.268	1.500	1.115	.875	.458	.750	.295	1.000	.500				
	2.125	1.847	2.000	1.687	1.625	1.268	1.500	1.115	1.625	1.208	1.500	1.045	1.000	.500	1.000	.444		
	2.125	1.847	2.000	1.687	2.125	1.768	1.500	1.115	1.625	1.208	1.500	1.045	1.000	.500	1.000	.444	1.000	.375
	2.625	2.347	2.500	2.187	2.125	1.768	2.250	1.865	1.625	1.208	1.500	1.045	1.000	.500	1.000	.444	1.000	.375
	2.625	2.347	2.500	2.187	2.625	2.268	2.250	1.865	2.375	1.958	2.250	1.795	2.000	1.500	1.000	.444	1.000	.375
	3.125	2.847	3.000	2.687	2.625	2.268	2.250	1.865	2.375	1.958	2.250	1.795	2.000	1.500	2.000	1.444	1.000	.375
	3.125	2.847	3.000	2.687	3.125	2.768	3.000	2.615	2.375	1.958	2.250	1.795	2.000	1.500	2.000	1.444	2.000	1.375
	3.625	3.347	3.500	3.187	3.125	2.768	3.000	2.615	3.125	2.708	3.000	2.545	2.000	1.500	2.000	1.444	2.000	1.375
	3.625	3.347	3.500	3.187	3.625	3.268	3.000	2.615	3.125	2.708	3.000	2.545	3.000	2.500	2.000	1.444	2.000	1.375
	4.125	3.847	4.000	3.687	3.625	3.268	3.750	3.365	3.125	2.708	3.000	2.545	3.000	2.500	3.000	2.444	2.000	1.375
	4.125	3.847	4.000	3.687	4.125	3.768	3.750	3.365	3.875	3.458	3.750	3.295	3.000	2.500	3.000	2.444	3.000	2.375
	4.625	4.347	4.500	4.187	4.125	3.768	3.750	3.365	3.875	3.458	3.750	3.295	3.000	2.500	3.000	2.444	3.000	2.375
	4.625	4.347	4.500	4.187	4.625	4.268	4.500	4.115	3.875	3.458	3.750	3.295	4.000	3.500	3.000	2.444	3.000	2.375
	5.125	4.847	5.000	4.687	4.625	4.268	4.500	4.115	4.625	4.208	4.500	4.045	4.000	3.500	4.000	3.444	3.000	2.375
			5.000	4.687	5.125	4.768	4.500	4.115	4.625	4.208	4.500	4.045	4.000	3.500	4.000	3.444	4.000	3.375
			5.500	5.187	5.125	4.768	5.250	4.865	4.625	4.208	4.500	4.045	4.000	3.500	4.000	3.444	4.000	3.375
			5.500	5.187	5.625	5.268	5.250	4.865	5.375	4.958	5.250	4.795	5.000	4.500	4.000	3.444	4.000	3.375
			6.000	5.687	5.625	5.268	5.250	4.865	5.375	4.958	5.250	4.795	5.000	4.500	5.000	4.444	4.000	4.375
					6.125	5.768	6.000	5.615	5.375	4.958	5.250	4.795	5.000	4.500	5.000	4.444	5.000	4.375
					6.125	5.768	6.000	5.615	6.125	5.708	6.000	5.545	5.000	4.500	5.000	4.444	5.000	4.375
					6.625	6.268	6.000	5.615	6.125	5.708	6.000	5.545	6.000	5.500	5.000	4.444	5.000	4.375
					7.125	6.768	7.000	6.615	6.875	6.458	6.750	6.295	6.000	5.500	6.000	5.444	5.000	5.375
					7.625	7.268	7.000	6.615	6.875	6.458	6.750	6.295	7.000	6.500	6.000	5.444	5.000	5.375
							8.000	7.615	7.625	7.208	7.750	7.295	7.000	6.500	7.000	6.444	7.000	6.375
							8.000	7.615	7.625	7.208	7.750	7.295	8.000	7.500	7.000	6.444	7.000	6.375
									9.125	8.708	9.250	8.795	9.000	8.500	8.000	7.444	8.000	7.375
									10.125	9.708	10.250	9.795	10.000	9.000	9.000	8.444	9.000	8.375
													11.000	10.500	10.000	9.444	10.000	9.375
													12.000	11.500	11.000	10.444	11.000	10.375
													13.000	12.500	12.000	11.444	12.000	11.375
															13.000	12.444	13.000	12.375
															14.000	13.444	14.000	13.375
															15.000	14.444	15.000	14.375
																16.000	15.375	
																17.000	16.375	

FEWER HOLES TO DRILL AND TAP

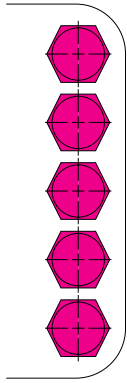

three screws do the work of five

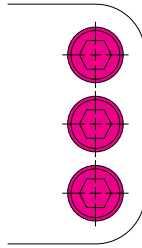

old method

5-3/8-16 screws @
120,000 psi tensile
85,000 psi yield =
 $5 \times 85,000 \times .0775 =$
33,000 lbs. max. load

UNBRAKO method

3-3/8-16 screws @
190,000 psi tensile
170,000 psi yield =
 $3 \times 170,000 \times .0775 =$
39,000 lbs. max. load

COMPACT SPACING

clearance for socket wrench

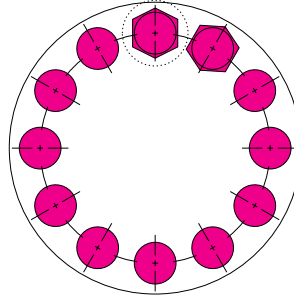

no wrench clearance necessary

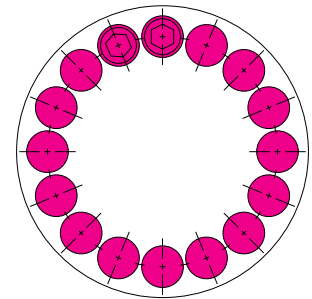

old method

12-3/4-16 hexagon
head screws @
120,000 psi tensile
strength
Total strength =
537,000 lbs.

UNBRAKO method

16-3/4-16 socket head
cap
screws @ 180,000 psi
tensile strength
Total strength =
1,074,200 lbs.

HIGH TENSILE AND YIELD STRENGTH

ordinary bolts

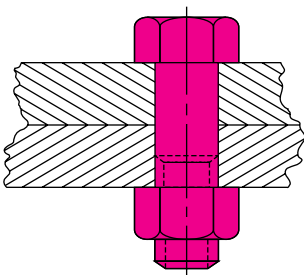

socket head cap screws

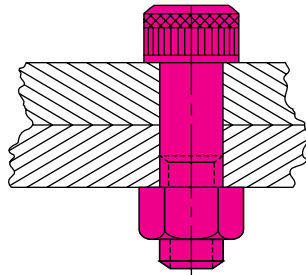

old method

120,000 psi. 1/2-20 bolt
tensile = 19,200 lbs.
yield = 13,600 lbs.

UNBRAKO method

190,000 psi 1/2-20
UNBRAKO
tensile = 30,400 lbs.
yield = 27,200 lbs.
**Extra UNBRAKO joint
strength:**
tensile – 58% increase
yield – 100% increase

HIGH SHEAR STRENGTH

ordinary bolts

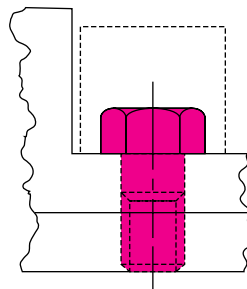

socket head cap screws

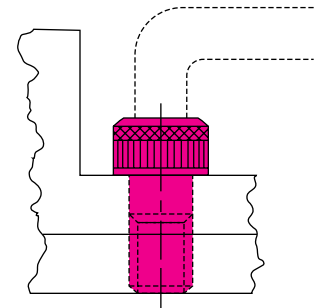

old method

120,000 psi. 1/2-20 bolt
Shear strength =
14,100 lbs.

UNBRAKO method

190,000 psi. 1/2-20
UNBRAKO
Shear strength =
22,400 lbs.
**Extra UNBRAKO shear
strength = 8,300 lbs.
less wrenching space
needed**

LOW HEAD CAP SCREWS

SOCKET HEAD CAP SCREWS ■ Low Head Type

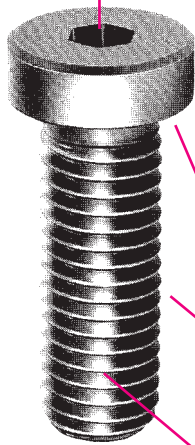

Smooth, burr-free sockets, uniformly concentric and usable to full depth for correct wrench engagement.

Low head height for thin parts and limited space.

Fillet under head increases fatigue life of head-to-shank junction.

Class 3A rolled threads with radiused root to increase fatigue life of threads by reducing stress concentrations and avoiding sharp corners where failures start.

Highest standards of quality, material, manufacture and performance.

High strength, precision fasteners for use in parts too thin for standard height socket cap screw and for applications with limited clearances.

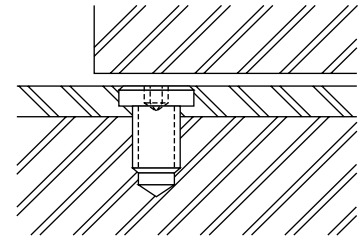

LENGTH TOLERANCE

Diameter	to 1"	over 1" to 2 1/2"	over 2 1/2"
All	-.03	-.04	-.06

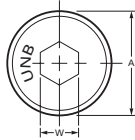

MECHANICAL PROPERTIES

Material: ASTM A574 – alloy steel

Hardness: Rc 38–43

Tensile Strength: 170,000 psi min.

Yield Strength: 150,000 psi min.

NOTE: Performance data listed are for standard production items only. Non-stock items may vary due to variables in methods of manufacture. It is suggested that the user verify performance on any non-standard parts for critical applications.

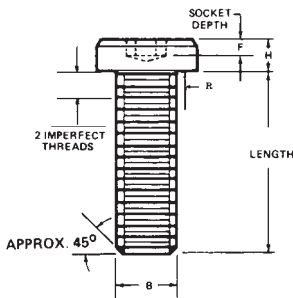

nominal size	tensile strength – lbs. min.		single shear strength in threads (calculated lbs.)		recommended* seating torque inch-lbs
	UNRC	UNRF	UNRC	UNRF	
#8	2,380	2,500	1,450	1,570	25
#10	2,980	3,400	1,700	2,140	35
1/4"	5,410	6,180	3,090	3,900	80
5/16"	8,910	9,870	4,930	6,210	157
3/8"	13,200	14,900	7,450	9,400	278
1/2"	24,100	27,200	13,600	17,100	667

DIMENSIONS

nom. size	basic screw diameter	threads per inch		A		B	F	H		R fillet extension		W
		UNRC	UNRF	max.	min.	basic	min.	max.	min.	max.	min.	nom.
#8	.164	32	36	.270	.265	0.1640	.060	.085	.079	.012	.007	.0781
#10	.190	24	32	.312	.307	0.1900	.072	.098	.092	.014	.009	.0938
1/4"	.250	20	28	.375	.369	0.2500	.094	.127	.121	.014	.009	.1250
5/16"	.312	18	24	.437	.431	0.3125	.110	.158	.152	.017	.012	.1562
3/8"	.375	16	24	.562	.556	0.3750	.115	.192	.182	.020	.015	.1875
1/2"	.500	13	20	.750	.743	0.5000	.151	.254	.244	.026	.020	.2500

Thread Length: On all stock lengths the last complete (full form) thread measured with a thread ring gage extends to within two threads of the head.

Threads: Threads are Class 3A UNRC and UNRF.

*Torque calculated to induce approximately 50,000 psi tensile stress in the screw threads (See Note, page 1).

SHOULDER SCREWS ■ Dimensions ■ Mechanical Properties ■ Seating Torques

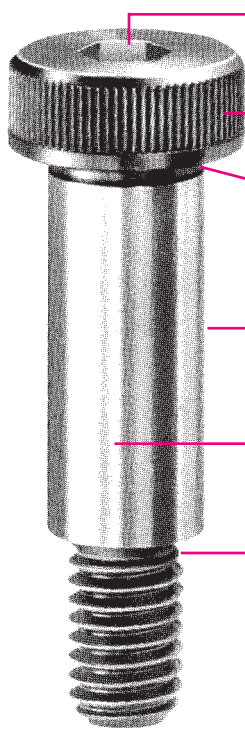

Precision hex socket for maximum wrenching strength

Knurled head for sure finger grip and fast assembly

Neck to allow assembly with minimal chamfering

Controlled concentricity between head and body for easier, more accurate assembly

Shoulder diameter held to .002 inch tolerance

Concentricity controlled between body and thread
Finished threads close to body for maximum holding power

Head sidewall may have straight knurls at mfrs. option

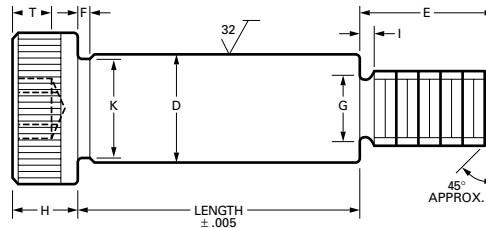
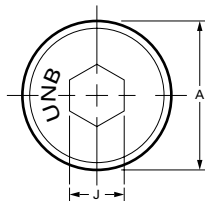

DIMENSIONS

nom. shoulder diameter	thread size	threads per inch UNRC	A		D		T	H		J	K	G	
			max.	min.	max.	min.	min.	max.	min.	nom.	min.	max.	min.
1/4	.190	24	.375	.357	.248	.246	.094	.188	.177	.125	.227	.142	.133
5/16	.250	20	.438	.419	.3105	.3085	.117	.219	.209	.156	.289	.193	.182
3/8	.312	18	.562	.543	.373	.371	.141	.250	.240	.188	.352	.249	.237
1/2	.375	16	.750	.729	.498	.496	.188	.312	.302	.250	.477	.304	.291
5/8	.500	13	.875	.853	.623	.621	.234	.375	.365	.312	.602	.414	.397
3/4	.625	11	1.000	.977	.748	.746	.281	.500	.490	.375	.727	.521	.502
1	.750	10	1.312	1.287	.998	.996	.375	.625	.610	.500	.977	.638	.616
1-1/4	.875	9	1.750	1.723	1.248	1.246	.469	.750	.735	.625	1.227	.750	.726
1-1/2	1.125	7	2.125	2.095	1.498	1.496	.656	1.000	.980	.875	1.478	.964	.934
1-3/4	1.250	7	2.375	2.345	1.748	1.746	.750	1.125	1.105	1.000	1.728	1.089	1.059
2	1.500	6	2.750	2.720	1.998	1.996	.937	1.250	1.230	1.250	1.978	1.307	1.277

NOTE: Performance data listed are for standard production items only. Non-stock items may vary due to variables in methods of manufacture. It is suggested that the user verify performance on any non-standard parts for critical applications.

SHOULDER SCREWS

Dimensions ■ Mechanical Properties ■ Seating Torques

APPLICATIONS

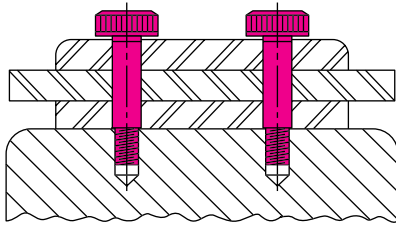

stationary guide

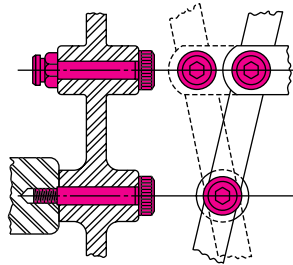

moving shaft or pivot

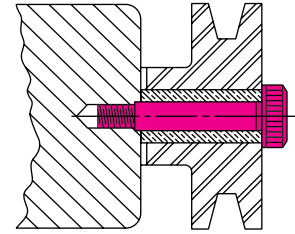

pulley shaft uses

Shoulder screws have an undercut portion between the thread and shoulder, allowing a close fit. They're used for a wide range of punch and die operations, such as the location and retention of stripper plates, and act as a guide in blanking and forming presses. Other applications for shoulder screws include: bearing pins for swing arms, links and levers, shafts for cam rolls and other rotating parts, pivots, and stud bolts. Shoulder screws are sometimes referred to as stripper bolts, resulting from their use with stripper plates and springs.

MECHANICAL PROPERTIES AND SEATING TORQUES

E thread length	F max.	I max.	T +.000 -.020	ult. tensile strength lbs. min.	single shear strength of body lbs. min.	recom.* mended seating torque inch-lbs.
.375	.093	.083	.094	2,220	4,710	45
.438	.093	.100	.117	4,160	7,360	112
.500	.093	.111	.141	7,060	10,500	230
.625	.093	.125	.188	10,600	18,850	388
.750	.093	.154	.234	19,810	29,450	990
.875	.093	.182	.281	31,670	42,410	1,975
1.000	.125	.200	.375	47,680	75,400	3,490
1.125	.125	.222	.469	66,230	117,800	5,610
1.500	.125	.286	.656	110,000	169,500	12,000
1.750	.125	.286	.750	141,000	231,000	16,000
2.000	.125	.333	.937	205,000	301,500	30,000

NOTES

Material: ANSI/ASME B18.3, ASTM A574 – alloy steel

Heat treatment: Rockwell C 36-43; 160,000 psi tensile strength.

Dimensions: ANSI/ASME B18.3

Concentricity: Head to body – within .005 T.I.R. when checked in "V" block equal to or longer than body length. Pitch diameter to body – within .004 T.I.R. when held in threaded bushing and checked at a distance of 3/16" from shoulder at threaded end.

Shoulder must rest against face of shoulder of standard "GO" ring gage. Bearing surface of head – perpendicular to axis of body with in 2° maximum deviation.

Tensile strength based on minimum neck area "G." Shear strength based on shoulder diameter "D."

Thread class: 3A

Screw point chamfer: The point shall be flat or slightly concave, and chamfered. The plane of the point shall be approximately normal to the axis of the screw. The chamfer shall extend slightly below the root of the thread, and the edge between flat and chamfer may be slightly rounded. The included angle of the point should be approximately 90°.

*See Note, page 1

FLAT HEAD SOCKET SCREWS

Dimensions

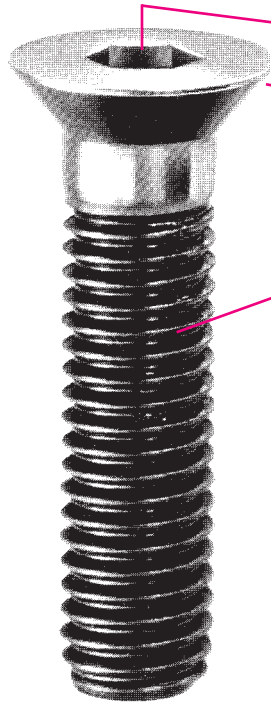

Deep, accurate socket for maximum key engagement

Uniform 82° angle under head for maximum contact

Fully formed threads for greater strength and precision fit

Continuous grain flow throughout the screw for increased strength

Heat treated alloy steel for maximum strength without brittleness or decarburization

See page 16 for mechanical properties and applications.

LENGTH TOLERANCE

Diameter	to 1"	over 1" to 2 1/2"	over 2 1/2" to 6"
#0 to 3/8" incl.	-.03	-.04	-.06
7/16 to 3/4" incl.	-.03	-.06	-.08
7/8 to 1" incl.	-.05	-.10	-.14

Dimensions: ANSI/ASME B18.3

Thread Class: 3A

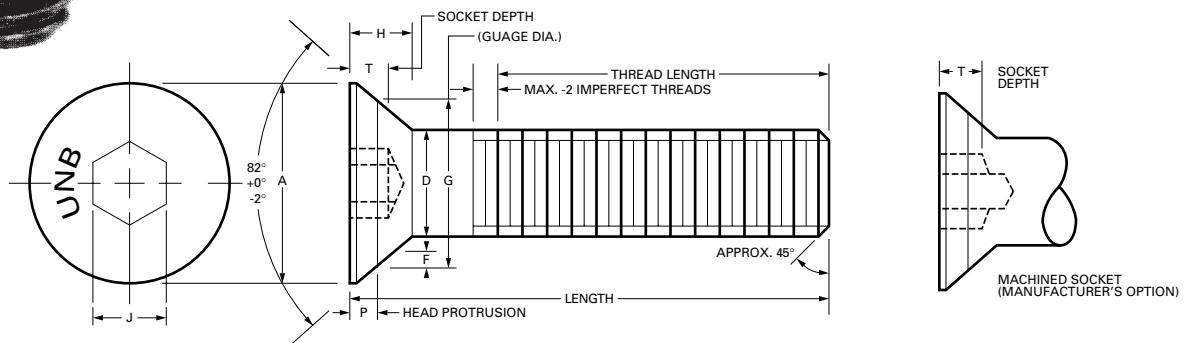

DIMENSIONS and APPLICATION DATA

nom. size	basic screw dia.	threads per inch		A head diameter		D body diameter		T	G protrusion gage diameter		H max. ref.	*** thd-to-hd max. ref.	P protrusion		F max.	J nom.
		UNRC	UNRF	max.*	min.**	max.	min.		max.	min.			max.	min.		
#0	.060	-	80	.138	.117	.060	.0568	.025	.078	.077	.044	.500	.034	.029	.006	.035
#1	.073	64	72	.168	.143	.073	.0695	.031	.101	.100	.054	.750	.038	.032	.008	.050
#2	.086	56	64	.197	.168	.086	.0822	.038	.124	.123	.064	.750	.042	.034	.010	.050
#3	.099	48	56	.226	.193	.099	.0949	.044	.148	.147	.073	.750	.044	.035	.010	.0625
#4	.112	40	48	.255	.218	.112	.1075	.055	.172	.171	.083	.875	.047	.037	.012	.0625
#5	.125	40	44	.281	.240	.125	.1202	.061	.196	.195	.090	.875	.048	.037	.014	.0781
#6	.138	32	40	.307	.263	.138	.1329	.066	.220	.219	.097	.875	.049	.037	.015	.0781
#8	.164	32	36	.359	.311	.164	.1585	.076	.267	.266	.112	1.000	.051	.039	.015	.0937
#10	.190	24	32	.411	.359	.190	.1840	.087	.313	.312	.127	1.250	.054	.041	.015	.1250
1/4	.250	20	28	.531	.480	.250	.2435	.111	.424	.423	.161	1.250	.059	.046	.015	.1562
5/16	.312	18	24	.656	.600	.3125	.3053	.135	.539	.538	.198	1.500	.063	.050	.015	.1875
3/8	.375	16	24	.781	.720	.375	.3678	.159	.653	.652	.234	1.750	.069	.056	.015	.2187
7/16	.437	14	20	.844	.781	.4375	.4294	.159	.690	.689	.234	2.000	.084	.071	.015	.2500
1/2	.500	13	20	.937	.872	.500	.4919	.172	.739	.738	.251	2.250	.110	.096	.015	.3125
5/8	.625	11	18	1.188	1.112	.625	.6163	.220	.962	.961	.324	2.500	.123	.108	.015	.3750
3/4	.750	10	16	1.438	1.355	.750	.7406	.220	1.186	1.185	.396	3.000	.136	.121	.015	.5000
7/8	.875	9	14	1.688	1.605	.875	.8647	.248	1.411	1.410	.468	3.250	.149	.134	.015	.5625
1	1.000	8	12	1.938	1.855	1.000	.9886	.297	1.635	1.634	.540	3.750	.162	.146	.015	.6250

* maximum – to theoretical sharp corners

** minimum – absolute with A flat

*** maximum product length, thread to head

NOTE: Performance data listed are for standard production items only. Non-stock items may vary due to variables in methods of manufacture. It is suggested that the user verify performance on any non-standard parts for critical application.

BUTTON HEAD CAP SCREWS

Dimensions

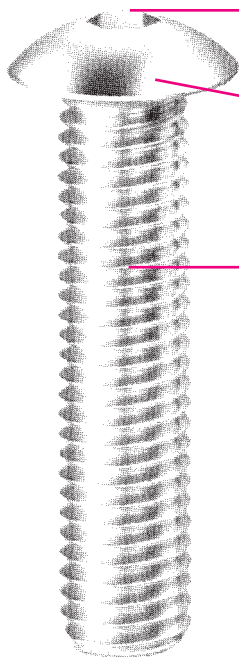

Precision hex socket for maximum key engagement

Low head height for modern streamline design

Fully formed threads rolled under extreme pressure provide greater strength

Continuous grain flow makes the whole screw stronger

Heat treated alloy steel for maximum strength without brittleness or decarburization

See page 16 for mechanical properties and applications.

LENGTH TOLERANCE

Diameter	to 1" incl.	over 1" to 2" incl.
To 1" incl.	-.03	-.04
Over 1" to 2"	-.03	-.06

Dimensions: ANSI/ASME B18.3

Thread Class: 3A

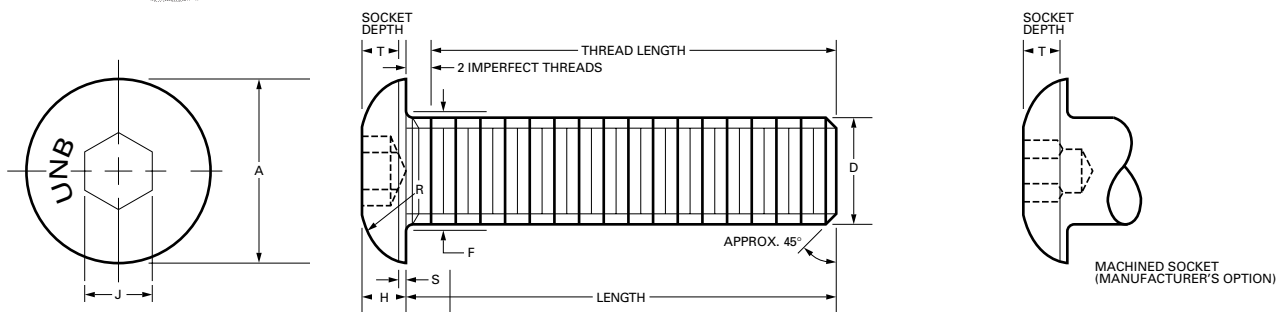

DIMENSIONS and APPLICATION DATA

nom. size	basic screw dia.	threads per inch		A head diameter		D body diameter		T	H head height		thd-to-hd max. ref.	S max.	R ref.	F fillet dia. max.	J min.
		UNRC	UNRF	max.	min.	max.	min.		max.	min.					
#0	.060	-	80	.114	.104	.060	.0568	.020	.032	.026	.500	.010	.070	.080	.035
#1	.073	64	72	.139	.129	.073	.0695	.028	.039	.033	.500	.010	.080	.093	.050
#2	.086	56	64	.164	.154	.086	.0822	.028	.046	.038	.500	.010	.099	.106	.050
#3	.099	48	56	.188	.176	.099	.0949	.035	.052	.044	.500	.010	.110	.119	.0625
#4	.112	40	48	.213	.201	.112	.1075	.035	.059	.051	.500	.015	.135	.132	.0625
#5	.125	40	44	.238	.226	.125	.1202	.044	.066	.058	.500	.015	.141	.145	.0781
#6	.138	32	40	.262	.250	.138	.1329	.044	.073	.063	.625	.015	.158	.158	.0781
#8	.164	32	36	.312	.298	.164	.1585	.052	.087	.077	.750	.015	.185	.194	.0937
#10	.190	24	32	.361	.347	.190	.1840	.070	.101	.091	1.000	.020	.213	.220	.1250
1/4	.250	20	28	.437	.419	.250	.2435	.087	.132	.122	1.000	.031	.249	.290	.1562
5/16	.312	18	24	.547	.527	.3125	.3053	.105	.166	.152	1.000	.031	.309	.353	.1875
3/8	.375	16	24	.656	.636	.375	.3678	.122	.199	.185	1.250	.031	.368	.415	.2187
1/2	.500	13	20	.875	.851	.500	.4919	.175	.265	.245	2.000	.046	.481	.560	.3125
5/8	.625	11	18	1.000	.970	.625	.6163	.210	.331	.311	2.000	.062	.523	.685	.3750

FLAT HEAD AND BUTTON HEAD SOCKET SCREWS

Mechanical Properties

NOTES

Material: ASTM F835 – alloy steel
ASTM F879 – stainless

Hardness: Rc 38–43 for alloy steel
Rb 96–Rc 33 for stainless steel

Tensile Strength: 160,000 PSI min. ultimate tensile strength for alloy steel
90,000 PSI min. ultimate tensile strength for stainless steel

Heat Treatment: Stainless steel is in cold-worked (CW) condition unless otherwise requested.

GENERAL NOTE

Flat, countersunk head cap screws and button head cap screws are designed and recommended for moderate fastening applications: machine guards, hinges, covers, etc. They are not suggested for use in critical high strength applications where socket head cap screws should be used.

MECHANICAL PROPERTIES

nom. size	ALLOY STEEL					STAINLESS STEEL				
	ultimate strength lbs.		single shear strength of body lbs. min.	seating torque inch-lbs.*		ultimate tensile strength lbs.		single shear strength of body lbs. min.	seating torque inch-lbs.*	
	UNRC	UNRF		UNRC	UNRF	UNRC	UNRF		UNRC	UNRF
#0	–	265	271	–	1.5	–	162	93	–	1.0
#1	390	390	402	2.5	2.5	237	250	137	1.7	1.8
#2	555	555	556	4.5	4.5	333	355	191	2.8	3.0
#3	725	725	739	7	7	438	471	253	4.3	4.6
#4	1,040	1,040	946	8	8	544	595	325	6.0	6.6
#5	1,260	1,310	1,180	12	13	716	747	403	8.9	9.3
#6	1,440	1,620	1,440	15	17	818	913	491	11	12
#8	2,220	2,240	2,030	30	31	1,260	1,327	693	20	21
#10	2,780	3,180	2,770	40	45	1,575	1,800	931	30	34
1/4	5,070	5,790	4,710	100	110	2,862	3,276	1,610	71	81
5/16	8,350	9,250	7,360	200	220	4,716	5,220	2,520	123	136
3/8	12,400	14,000	10,600	350	400	6,975	7,900	3,620	218	247
7/16	16,900	18,900	14,400	560	625	9,570	10,680	4,930	349	388
1/2	22,800	25,600	18,850	850	1,000	12,770	14,390	6,440	532	600
9/16	28,900	32,300	23,900	1,200	1,360	16,300	18,300	8,150	767	856
5/8	36,000	40,800	29,450	1,700	1,900	20,300	23,000	10,100	1,060	1,200
3/4	53,200	59,300	42,400	3,000	3,200	30,100	33,600	14,500	1,880	2,100
7/8	73,500	81,000	57,700	5,000	5,400	41,500	45,800	19,700	3,030	3,340
1	96,300	106,000	75,400	7,200	7,600	54,500	59,700	25,800	4,550	5,000

*Torques values listed are for plain screws to induce 65,000 psi stress in alloy steel and 30,000 psi tensile stress in stainless steel screw threads. For cadmium plated screws, multiply recommended seating torque by .75; for zinc plated screws multiply by 1.40. See Note, page 1.

SQUARE HEAD SET SCREWS

Dimensions ■ Application Data



Heat treated alloy steel for maximum strength without brittleness or decarburization

Fully formed threads with continuous grain flow for greater strength and precision fit

Knurled cup point for positive self-locking and vibration resistance

Threads per ANSI B 1.1; Handbook H-28. ANSI B18.6.2

VIBRATIONAL HOLDING POWER vs. SEATING TORQUE Size: 5/16" - 18x1/2"

GREATER TIGHTENING TORQUES of UNBRAKO Square Heads, made of high quality alloy steel, provide 50% more axial holding power than ordinary carbon steel square heads. And, because of the increased torque plus the Knurled Cup Point, UNBRAKO Square Head Set Screws deliver up to 400 percent more Vibrational Holding Power.

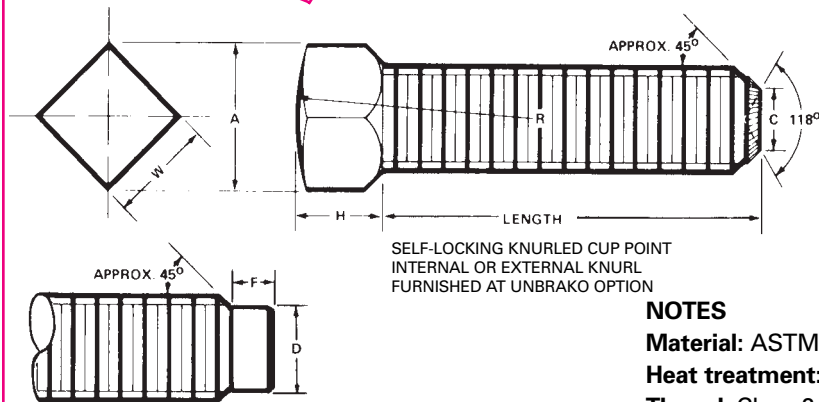
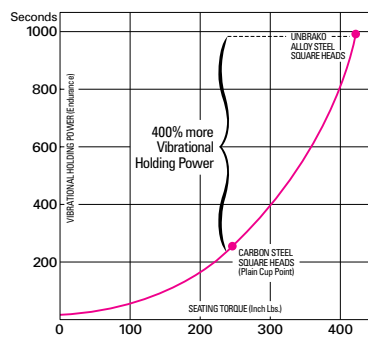

SELF-LOCKING KNURLED CUP POINT
INTERNAL OR EXTERNAL KNURL
FURNISHED AT UNBRAKO OPTION

NOTES

Material: ASTM A574 – alloy steel

Heat treatment: Rc 45 min., through heat treated

Thread: Class 2A.

These torques are appreciably higher than socket set screw torque values, therefore thread stripping strength of mating material must be considered.

LENGTH TOLERANCE

Diameter	up to 1" incl.	1" to 2" incl.	2" and over
up to 5/8"	-.03	-.06	-.09
3/4" and over	-.06	-.12	-.18

DIMENSIONS and APPLICATION DATA

nom. size	basic screw diameter	threads per inch	A min.	C		D		F ±.010	H		R nom.	W		recom.** torque inch-lbs.
				max.	min.	max.	min.		max.	min.		max.	min.	
#10	.190	24	.247*	.102	.88	.127	.120	.045	.148	.134*	31/64	.188	.180	100
1/4	.250	20	.331	.132	.118	.156	.149	.063	.196	.178	5/8	.250	.241	212
5/16	.312	18	.415	.172	.156	.203	.195	.078	.245	.224	25/32	.312	.302	420
3/8	.375	16	.497	.212	.194	.250	.241	.094	.293	.270	15/16	.375	.362	830
7/16	.437	14	.581	.252	.232	.297	.287	.109	.341	.315	1 3/32	.437	.423	1,350
1/2	.500	13	.665	.291	.270	.344	.334	.125	.389	.361	1 1/4	.500	.484	2,100
9/16	.562	12	.648	.332	.309	.391	.379	.140	.437	.407	1 13/32	.562	.545	2,850
5/8	.652	11	.833	.371	.347	.469	.456	.156	.485	.452	1 9/16	.625	.606	4,250
3/4	.750	10	1.001	.450	.425	.563	.549	.188	.582	.544	1 7/8	.750	.729	7,700
7/8	.875	9	1.170	.530	.502	.656	.642	.219	.678	.635	2 3/16	.875	.852	12,600
1	1.000	8	1.337	.609	.579	.750	.734	.250	.774	.726	2 1/2	1.000	.974	16,600
1 1/8	1.125	7	1.505	.689	.655	.844	.826	.281	.870	.817	2 13/16	1.125	1.096	20,800
1 1/4	1.250	7	1.674	.767	.733	.938	.920	.312	.966	.908	3 1/8	1.250	1.219	25,000
1 3/8	1.375	6	1.843	.848	.808	1.031	1.011	.344	1.063	1.000	3 7/16	1.375	1.342	32,000
1 1/2	1.500	6	2.010	.926	.886	1.125	1.105	.375	1.159	1.091	3 3/4	1.500	1.464	44,000

*#10 may have head dimensions from 1/4 nominal size furnished at Unbrako option. **See Note, page 1.

SOCKET SET SCREWS ■ Dimensions ■ Application Data ■ Seating Torques

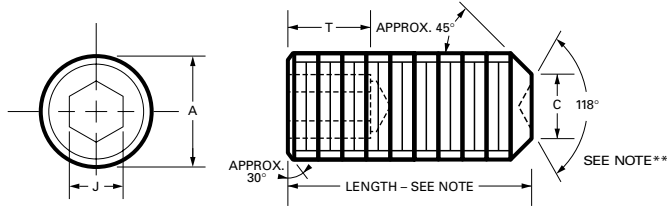

LENGTH TOLERANCE

Diameter	.63 and under	over .63 to 2"	over 2" to 6"	over 6"
All	±.01	±.02	±.03	±.06

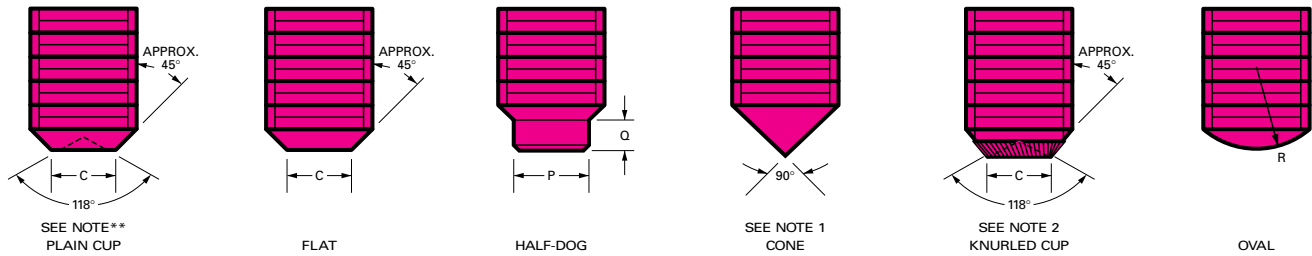

DIMENSIONS

nom. size	basic screw diameter	threads per inch		A			C		P	
		UNRC	UNRF	max.	UNRC	UNRF	max.	min.	max.	min.
#0	.060	—	80	.0600	—	.0568	.033	.027	.040	.037
#1	.073	64	72	.0730	.0692	.0695	.040	.033	.049	.045
#2	.086	56	64	.0860	.0819	.0822	.047	.039	.057	.053
#3	.099	48	56	.0990	.0945	.0949	.054	.045	.066	.062
#4	.112	40	48	.1120	.1069	.1075	.061	.051	.075	.070
#5	.125	40	44	.1250	.1199	.1202	.067	.057	.083	.078
#6	.138	32	40	.1380	.1320	.1329	.074	.064	.092	.087
#8	.164	32	36	.1640	.1580	.1585	.087	.076	.109	.103
#10	.190	24	32	.1900	.1825	.1840	.102	.088	.127	.120
1/4	.250	20	28	.2500	.2419	.2435	.132	.118	.156	.149
5/16	.312	18	24	.3125	.3038	.3053	.172	.156	.203	.195
3/8	.375	16	24	.3750	.3656	.3678	.212	.194	.250	.241
7/16	.437	14	20	.4375	.4272	.4294	.252	.232	.297	.287
1/2	.500	13	20	.5000	.4891	.4919	.291	.207	.344	.334
9/16	.562	12	18	.5625	.5511	.5538	.332	.309	.390	.379
5/8	.625	11	18	.6250	.6129	.6163	.371	.347	.469	.456
3/4	.750	10	16	.7500	.7371	.7406	.450	.425	.562	.549
7/8	.875	9	14	.8750	.8611	.8647	.530	.502	.656	.642
1	1.000	8	12	1.0000	.9850	.9886	.609	.579	.750	.734
1 1/8	1.125	7	12	1.1250	1.1086	1.1136	.689	.655	.844	.826
1 1/4	1.250	7	12	1.2500	1.2336	1.2386	.767	.733	.938	.920
1 3/8	1.375	6	12	1.3750	1.3568	1.3636	.848	.808	1.031	1.011
1 1/2	1.500	6	12	1.5000	1.4818	1.4886	.926	.886	1.125	1.105

NOTE: Performance data listed are for standard production items only. Non-stock items may vary due to variables in methods of manufacture. It is suggested that the user verify performance on any non-standard parts for critical applications.

SOCKET SET SCREWS

Dimensions ■ Application Data ■ Seating Torques

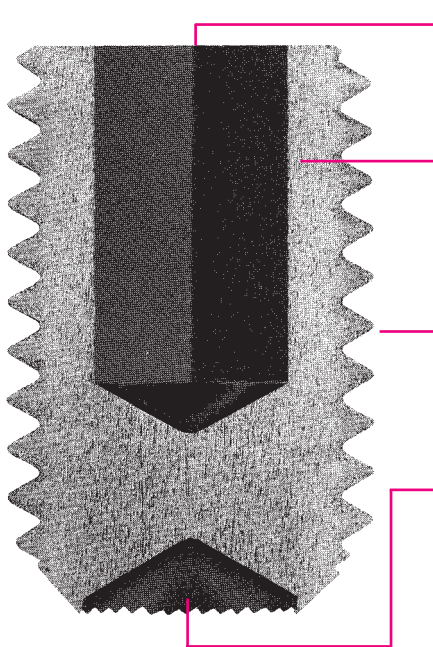

Deep socket – Key fits deeply into socket to provide extra wrenching area for tighter tightening without reaming the socket or rounding off corners of key

Continuous grain flow – Flow lines of rolled threads follow closely the contour of the screw

Fully formed threads – are rolled, not cut or ground. Metal is compressed, making it extra strong. Threads resist shearing, withstand higher tightening torques

Class 3A threads – Formed with closest interchangeable fit for maximum cross-section with smooth assembly. Assure better mating of parts

Counterbored knurled cup point

NOTES

Material: ASTM F912 – alloy steel
ASTM F880 – stainless steel

Dimensions: ASME/ANSI B18.3

Hardness: Rc 45-53 (alloy steel only),
Rb 96-Rc 33 (stainless steel)

Thread class: 3A

1. When length equals nominal diameter or less, included angle is 118°. (#4 x 1/8 and #8 x 3/16 also have 118 angle)

2. When length equals nominal diameter or less, included angle is 130°.

DIMENSIONS

RECOMMENDED SEATING TORQUES – INCH-LBS.**

	Q		T*	J	R	Applicable only to nominal minimum lengths shown or longer			
	max.	min.				min.	nom.	basic	alloy steel
	.017	.013	.035	.028	.045	1.0	.4	3/32	.050
	.021	.017	.035	.035	.055	1.8	1.2	1/8	.060
	.024	.020	.035	.035	.064	1.8	1.2	1/8	.060
	.027	.023	.060	.050	.074	5	4	5/32	.070
	.030	.026	.075	.050	.084	5	4	5/32	.070
	.033	.027	.075	.0625	.094	10	7	5/32	.080
	.038	.032	.075	.0625	.104	10	7	3/16	.080
	.043	.037	.075	.0781	.123	20	16	3/16	.090
	.049	.041	.105	.0937	.142	36	26	3/16	.100
	.067	.059	.105	.125	.188	87	70	5/16	.125
	.082	.074	.140	.1562	.234	165	130	3/8	.156
	.099	.089	.140	.1875	.281	290	230	7/16	.188
	.114	.104	.190	.2187	.328	430	340	1/2	.219
	.130	.120	.210	.250	.375	620	500	9/16	.250
	.146	.136	.265	.250	.422	620	500	5/8	.250
	.164	.148	.265	.3125	.469	1,325	980	11/16	.312
	.196	.180	.330	.375	.562	2,400	1,700	3/4	.375
	.227	.211	.450	.500	.656	3,600	3,000	3/4	.500
	.260	.240	.550	.5625	.750	5,000	4,000	7/8	.562
	.291	.271	.650	.5625	.844	7,200	5,600	1	.562
	.323	.303	.700	.625	.938	9,600	7,700	1 1/8	.625
	.354	.334	.700	.625	1.031	9,600	7,700	1 1/4	.625
	.385	.365	.750	.750	1.125	11,320	9,100	1 1/4	.750

***CAUTION:** Values shown in column T are for minimum stock length cup point screws. Screws shorter than nominal minimum length shown do not have sockets deep enough to utilize full key capability which can result in failure of socket, key or mating threads.

**See Note, page 1.

SOCKET SET SCREWS ■ Point Selection According to Application

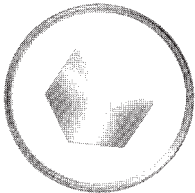
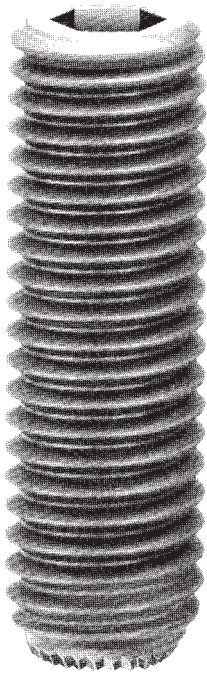

Socket set screws offer three types of holding power: torsional (resistance to rotation); axial (resistance to lateral movement); and vibrational.

Size selection is an important factor in holding power. The screw diameter should be roughly 1/2 that of the shaft as a rule-of-thumb. (For more specific size data see pages 18–19.) Additional design considerations appear below.

Holding power is almost directly proportional to seating torque in a cup, flat, and oval point screws. Holding power can be increased by increasing seating torque. Greater holding power reduces the number of screws required and the assembled cost of the application.

By its penetration, the set screw point can add as much as 15% to total holding power. Cone points, with

deepest penetration, give the greatest increase; oval points, with minimum penetration, the least. Making 1 the index for cup point, holding power values from tables on pages 22 and 23 can be multiplied by 1.07 for cone point, 0.92 for flat or dog points, and 0.90 for oval point.

Relative hardness between set screw and shaft is also a factor. A 10-point differential between the screw's normal Rockwell C 50 and shaft should be maintained for full holding power. As much as 15% loss in holding power can result from a lower differential.

Vibration resistance can be achieved by correct size and proper tightening. The UNBRAKO knurl cup set screw offers additional mechanical locking resistance when required.

POINT SELECTION

According to Application

Point selection is normally determined by the nature of the application – materials, their relative hardness, frequency of assembly and re-assembly and other factors. Reviewed here are standard point types, their general features and most frequent areas of application of each type.

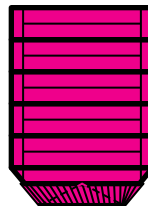

knurled cup

For quick and permanent location of gears, collars, pulleys or knobs on shafts. Exclusive counterclockwise locking knurls resist screw loosening, even in poorly tapped holes. Resists most severe vibration.

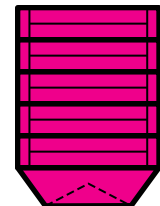

plain cup

Use against hardened shafts, in zinc, die castings and other soft materials where high tightening torques are impractical.

SOCKET SET SCREWS

Point Selection According to Application

STAINLESS STEEL ADVANTAGES

- Corrosion resistance, Wide temperature range (-300°F to $+800^{\circ}\text{F}$), Freedom from scaling or oxidation.
- Non-magnetic, a valuable property in certain electrical and electronic applications. (Maximum permeability is 1.2 and can be reduced to 1.02 by bright annealing.) Corrosion-resistance useful where cleanliness is important.
- Standard processing of these socket set screws includes a passivation treatment which neutralizes surface contamination.

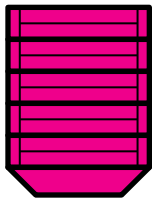

flat

Use where parts must be frequently re-set, as it causes little or no damage to part it bears against. Can be used against hardened shafts (usually with ground flat for better contact) and as adjusting screw. Preferred for thin wall thickness and on soft plugs.

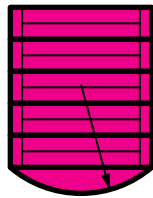

oval

Use for frequent adjustment without deformation of part it bears against, also for seating against an angular surface. Circular U-grooves or axial V-grooves sometimes put in shaft to permit rotational or longitudinal adjustment.

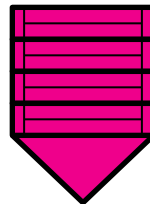

cone

For permanent location of parts. Deep penetration gives highest axial and holding power. In material over Rockwell C15 point is spotted to half its length to develop shear strength across point. Used for pivots and fine adjustment.

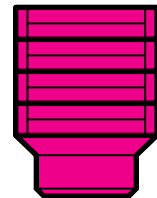

half dog

Used for permanent location of one part to another. Point is spotted in hole drilled in shaft or against flat (milled). Often replaces dowel pins. Works well against hardened members or hollow tubing.

SOCKET SET SCREWS ■ Torsional and Axial Holding Power

SIZE SELECTION OF SOCKET SET SCREWS

The user of a set-screw-fastened assembly is primarily buying static holding power. The data in this chart offers a simplified means for selecting diameter and seating torque of a set screw on a given diameter shaft.

Torsional holding power in inch-pounds and axial holding power in pounds are tabulated for various cup point socket screws, seated at recommended installation torques. Shafting used was hardened to Rockwell C15. Test involved Class 3A screw threads in Class 2B tapped holes. Data was determined experimentally in a long series of tests in which holding power was defined as the minimum load to produce 0.010 inch relative movement of shaft and collar.

From this basic chart, values can be modified by percentage factors to yield suitable design data for almost any standard set screw application.

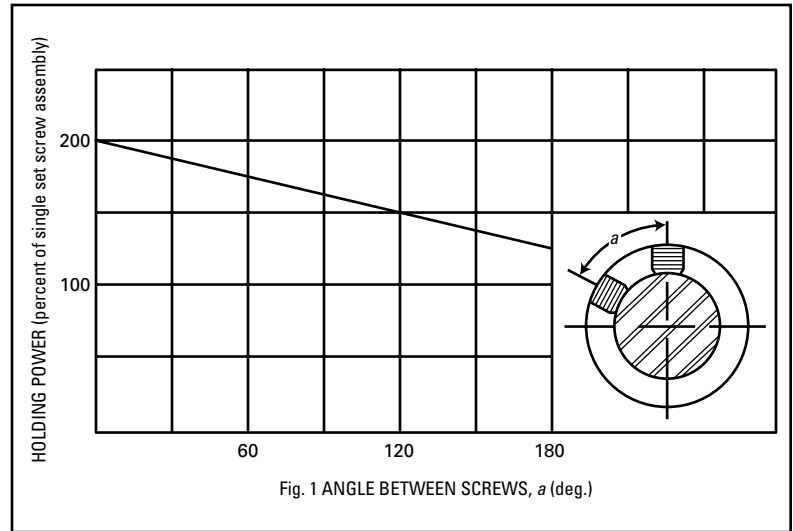

NOTES

Tabulated axial and torsional holding powers are typical strengths and should be used accordingly, with specific safety factors appropriate to the given application and load conditions. Good results have been obtained with a factor of 1.5-2.0 under static load conditions (i.e., where a collar is supporting a vertical load on a post) and of 4.0-8.0 for various dynamic situations.

Values in bold type in the chart indicate recommended set screw sizes on the basis that screw diameter should be roughly one-half shaft diameter.

TORSIONAL and AXIAL HOLDING POWER (Based on Recommended Seating Torques – Inch-Lbs.)

nom. size	seating torque inch-lbs.	axial holding power (pounds)	shaft diameter (shaft hardness Rc 15 to Rc 35)											
			1/16	3/32	1/8	5/32	3/16	7/32	1/4	5/16	3/8	7/16	1/2	9/16
			torsional holding power inch-lbs.											
#0	1.0	50	1.5	2.3	3.1	3.9	4.7	5.4	6.2					
#1	1.8	65	2.0	3.0	4.0	5.0	6.1	7.1	8.1	10.0				
#2	1.8	85	2.6	4.0	5.3	6.6	8.0	9.3	10.6	13.2	16.0			
#3	5	120	3.2	5.6	7.5	9.3	11.3	13.0	15.0	18.7	22.5	26.3		
#4	5	160		7.5	10.0	12.5	15.0	17.5	20.0	25.0	30.0	35.0	40.0	
#5	10	200			12.5	15.6	18.7	21.8	25.0	31.2	37.5	43.7	50.0	56.2
#6	10	250				19	23	27	31	39	47	55	62	70
#8	20	385				30	36	42	48	60	72	84	96	108
#10	36	540					51	59	68	84	101	118	135	152
1/4	87	1,000							125	156	187	218	250	281
5/16	165	1,500								234	280	327	375	421
3/8	290	2,000									375	437	500	562
7/16	430	2,500										545	625	702
1/2	620	3,000											750	843
9/16	620	3,500												985
5/8	1,325	4,000												
3/4	2,400	5,000												
7/8	3,600	5,600												
1	5,000	6,500												

SOCKET SET SCREWS

Torsional and Axial Holding Power

If you know set screws, you know that the tighter you can tighten them, the better they hold and the more they resist loosening from vibration. But there's a limit to how much you can tighten the average socket set screw. If you're not careful, you can ream or crack the socket, and in some cases, even strip the threads. So you're never quite sure whether or not it will actually stay tight.

With UNBRAKO set screws it's a different story. A unique combination of design and carefully controlled manufacturing and heat treating gives these screws extra strength that permits you to tighten them appreciably tighter than ordinary screws with minimal fear of reaming or cracking the socket. This extra strength represents a substantial bonus of extra holding power and the additional safety and reliability that goes with it.

Design – Deeper UNBRAKO sockets give more key engagement to let you seat the screws tighter. Corners are radiused to safeguard against reaming or cracking the socket when the extra tightening torque is applied. The sharp corners of other set screws create high stress concentrations and

can cause cracking, even at lower tightening torques. By eliminating the corners, the radii distribute tightening stresses to reduce the chance of splitting to a minimum.

Controlled Manufacturing – The fully-formed threads of UNBRAKO set screws are rolled under extreme pressure to minimize stripping and handle the higher tightening torques. Also, with rolled threads, tolerances can be more closely maintained. UNBRAKO set screws have Class 3A threads, closest interchangeable fit, giving maximum cross-section with smooth assembly. The thread form itself has the radiused root that increases the strength of the threads and resistance to shear.

Controlled Heat Treatment – This is the third element of the combination. Too little carbon in the furnace atmosphere (decarburization) makes screws soft, causing reamed sockets, stripped threads and sheared points when screws are tightened. Too much carbon (carburization) makes screws brittle and liable to crack or fracture. The heat treatment is literally tailored to each "heat" of UNBRAKO screws, maintaining the necessary controlled

Rc 45-53 hardness for maximum strength.

Finally, point style affects holding power. As much as 15% more can be contributed, depending on the depth of penetration. The cone point (when used without a spotting hole in the shaft) gives greatest increase because of its greater penetration. The oval point, with the least contact area, affords the least. The cup point lies in between, but is by far the most commonly used, because of the wide range of applications to which it is adaptable.

However, there is one cup point that can give you both a maximum of holding power and of resistance to vibration. It is the exclusive UNBRAKO knurled cup point, whose locking knurls bite into the shaft and resist the tendency of the screw to back out of the tapped hole. The chart on this page shows clearly how much better the UNBRAKO set screws resist vibration in comparison with plain cup point set screws. UNBRAKO knurled cup point self-locking set screws give you excellent performance under conditions of extreme vibration.

UNBRAKO SOCKET SET SCREWS – UNRC or UNRF Thread – Seated Against Steel Shaft

nom. size	seating torque inch-lbs.	axial holding power (pounds)	shaft diameter (shaft hardness Rc 15 to Rc 35)												
			5/8	3/4	7/8	1	1 1/4	1 1/2	1 3/4	2	2 1/2	3	3 1/2	4	
			torsional holding power inch-lbs.												
#0	1.0	50													
#1	1.8	65													
#2	1.8	85													
#3	5	120													
#4	5	160													
#5	10	200	62												
#6	10	250	78	94	109										
#8	20	385	120	144	168	192									
#10	36	540	169	202	236	270	338								
1/4	87	1,000	312	357	437	500	625	750							
5/16	165	1,500	468	562	656	750	937	1125	1310	1500					
3/8	290	2,000	625	750	875	1000	1250	1500	1750	2000					
7/16	430	2,500	780	937	1095	1250	1560	1875	2210	2500	3125				
1/2	620	3,000	937	1125	1310	1500	1875	2250	2620	3000	3750	4500			
9/16	620	3,500	1090	1310	1530	1750	2190	2620	3030	3500	4370	5250	6120		
5/8	1,325	4,000	1250	1500	1750	2000	2500	3000	3750	4000	5000	6000	7000	8000	
3/4	2,400	5,000		1875	2190	2500	3125	3750	4500	5000	6250	7500	8750	10000	
7/8	3,600	5,600			2620	3000	3750	4500	5250	6000	7500	9000	10500	12000	
1	5,000	6,500				3500	4375	5250	6120	7000	8750	10500	12250	14000	

PRESSURE PLUGS

DRYSEAL TYPE with 3/4-inch taper per foot

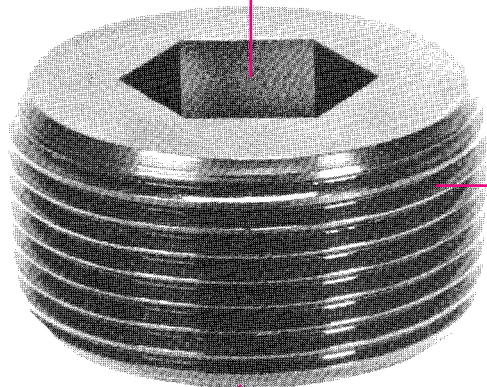

Precision hex socket with maximum depth for positive wrenching at higher seating torques

Dryseal-thread form achieves a seal without need for compound

Heat treated alloy steel for strength

Roundness-closely controlled for better sealing

Uniform taper of 3/4 inch per foot

Controlled chamfer for faster starting

Threads NPTF per ANSI B1.20.3

See Notes on page 25

See Application Data on page 26

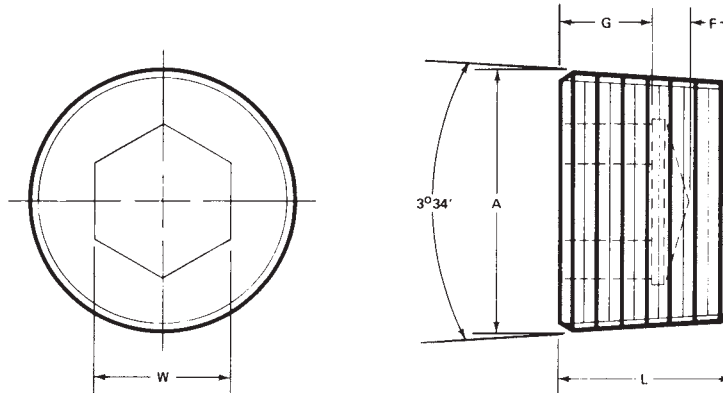

DIMENSIONS

nominal thread size		threads per in.	A ref.	F min.	G min.	L ±.010	W nom.	X note 4	basic thread dimension		
									E ₀	E ₁	L ₁
1/16	.062	27	.318	.062	.140	.312	.156	.003	.27118	.28118	.160
1/8	.125	27	.411	.062	.140	.312	.188	.003	.36351	.37360	.1615
1/4	.250	18	.545	.073	.218	.437	.250	.003	.47739	.49163	.2278
3/8	.375	18	.684	.084	.250	.500	.312	.005	.61201	.62701	.240
1/2	.500	14	.847	.095	.312	.562	.375	.005	.75843	.77843	.320
3/4	.750	14	1.061	.125	.312	.625	.562	.007	.96768	.98887	.339
1	1.000	11 1/2	1.333	.125	.375	.750	.625	.007	1.21363	1.23863	.400
1 1/4	1.250	11 1/2	1.679	.156	.437	.812	.750	.010	1.55713	1.58338	.420
1 1/2	1.500	11 1/2	1.918	.156	.437	.812	1.000**	.010	1.79609	1.82234	.420
2	2.000	11 1/2	2.395	.156	.437	.875	1.000	.010	2.26902	2.29627	.436

** .750 for LEVL-SEAL

PRESSURE PLUGS

LEVL SEAL® TYPE Dryseal Thread Form with 7/8-inch per foot

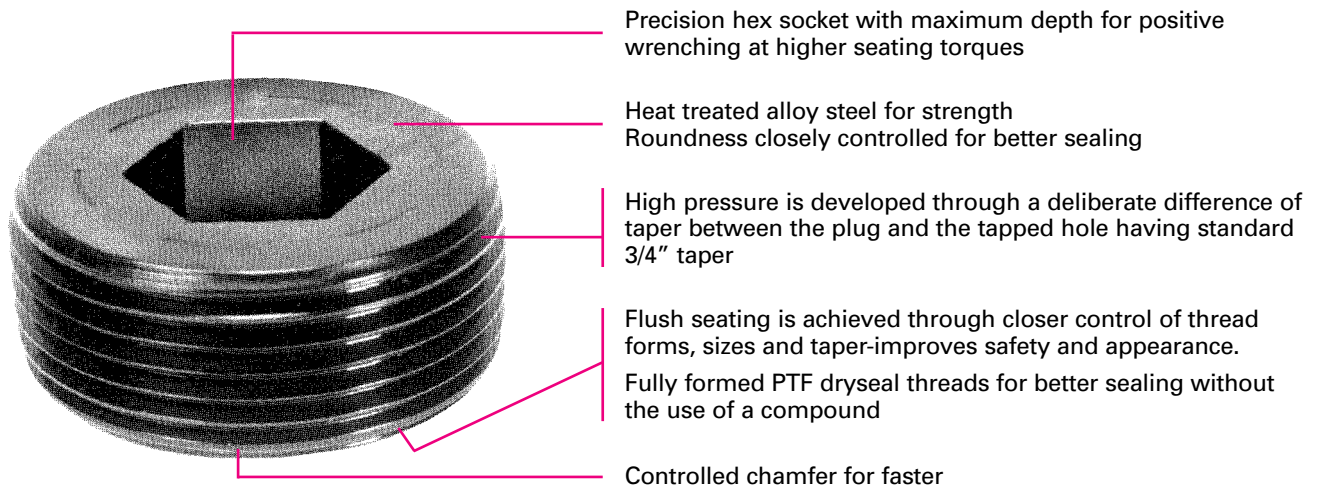

See Application Data on page 27

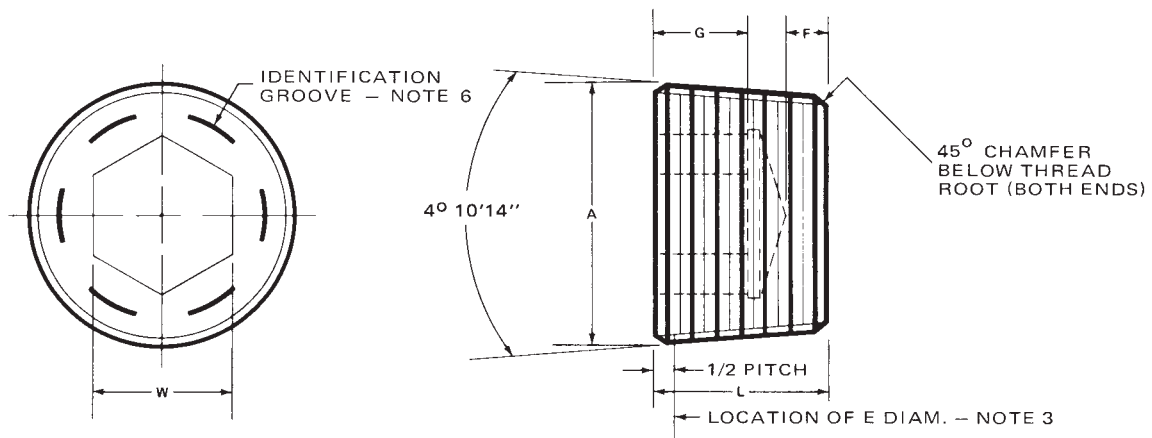

DIMENSIONS*

nominal thread size	A ref.	F min.	G min.	L +.000 - .015	E note 3 ref.
1/16	.062	.307	.052	.141	.28118
1/8	.125	.401	.049	.141	.37360
1/4	.250	.529	.045	.266	.49163
3/8	.375	.667	.040	.266	.62701
1/2	.500	.830	.067	.329	.77843
3/4	.750	1.041	.054	.329	.98887
1	1.000	1.302	.112	.360	1.23863
1 1/4	1.250	1.647	.102	.360	1.58338
1 1/2	1.500	1.885	.102	.360	1.82234
2	2.000	2.360	.084	.360	2.29627

NOTES

- Material:** ASTM A574 alloy steel, austenitic stainless steel or brass.
- Hardness:** Rc 35-40 for steel.
- Basic pitch diameter:** E-pitch dia. at a distance of one-half pitch from large end of plug. PTF thread from 7/8-inch taper per foot. E0 – pitch diameter at small end of plug; E1 – pitch diameter at L1 distance from end of plug; L1 – length of hand-tight engagement.
- Bottom of plug to be flat within "X" T.I.R. DRY-SEAL and LEVL-SEAL: Small end of plug to be flush with face of standard NPTF ring gages within one thread (L1, L2 and tapered ring). Large end of plug to be flush with face of special 7/8 taper ring gages within one-half thread.
- Undercut in socket at mfrs. option
- Six equally spaced identification grooves (1/16-27 plug to have 3 identification grooves) on alloy steel plugs. (LEVL-SEAL)
- Dimensions apply before plating and/or coating.

See page 24 for threads per inch, w nom., and X.
*Dimensions before coating for PTFE/TEFLON-coated LEVL-SEAL pressure plugs.

PRESSURE PLUGS ■ Application Data

Pressure plugs are not pipe plugs. Pipe plugs (plumber's fittings) are limited to pressures of 600 psi, are sealed with a compound, and are made of cast iron with cut threads and protruding square drive.

Pressure plugs are made to closer tolerances, are generally of higher quality, and almost all have taper threads. Properly made and used, they will seal at pressures to 5000 psi and without a sealing compound (pressure tests are usually at 20,000 psi.) they are often used in hydraulic and pneumatic designs.

Performance Requirements

Pressure plugs used in industrial applications should:

- not leak at pressures to 5000 psi
- need no sealing compounds
- be reusable without seizure
- give a good seal when reused
- seal low viscosity fluids
- require minimum seating torque
- require minimum re-tooling or special tools.

For a satisfactory seal, the threads of the plug and those in the mating hole must not gall or seize up to maximum

possible tightening torque. Galling and seizure are caused by metal pickup on the mating surfaces and are directly related to force on the surface, material hardness, lubrication used, and thread finish.

How Pressure Plugs Seal

Sealing is achieved by crushing the crest of one thread against the root of the mating thread. If too much of compressive force is required to torque the plug, it will tend to gall in the hole. Too little force will not deform the crest of threads enough to produce a seal. Increasing the hardness of the material will reduce galling but will also increase the required sealing force. Generally a hardness range of Rc 30 to 40 will meet most requirements. The tightening force must be low enough to cause no galling in this range.

Cost Considerations

Dryseal plugs are more frequently used, especially where reuse is frequent. Reason: more threads are engaged and they therefore resist leakage better. They are also preferred in soft metals to reduce of over-torquing.

TYPES OF PRESSURE PLUG THREADS

Three thread forms are commonly used for pipe plugs and pressure plugs:

NPT: National Pipe thread, Tapered. This is the thread form commonly used for commercial pipe and fittings for low pressure applications. A lubricant and sealer are generally used.

ANPT: Aeronautical National Pipe thread, Tapered. Covered by MIL-S-7105, this thread form was developed for aircraft use. It is basically the same as the NPT thread except that tolerances have been reduced about 50 percent. Plugs made with this thread should be used with lubricants and sealers. They are not to be used for hydraulic applications.

NPTF: National Pipe thread, Tapered, Fuel. This is the standard thread for pressure plugs. They make pressure-tight joints without a sealant. Tolerances are about 1/4 those for NPT threads. The standard which applies is ANSI B1.20.3. Applicable for fluid power applications.

APPLICATION DATA – DRYSEAL TYPE

nom. size	threads per inch	tap drill size+	tap drill size ++	recommended torque in.-lbs*	
1/16	27	15/64	1/4	150	Unbrako recommends using a tapered reamer with corresponding size tap drill (see page 27). +With use of reamer (taper thread). ++Without use of tapered reamer. *Recommended torques for alloy steel only. Multiply by .65 for stainless steel and .50 for brass. NPTF fully formed Dryseal threads achieve seal in tapped holes without need for sealing compounds.
1/8	27	21/64	11/32	250	
1/4	18	27/64	7/16	600	
3/8	18	9/16	37/64	1200	
1/2	14	11/16	23/32	1800	
3/4	14	57/64	59/64	3000	
1	11 1/2	1 1/8	1 5/32	4200	
1 1/4	11 1/2	37.5mm	–	5400	
1 1/2	11 1/2	43.5mm	–	6900	
2	11 1/2	2 3/16	–	8500	

PRESSURE PLUGS

PTFE/TEFLON-Coated LEVEL-SEAL Type Dryseal Thread Form with 7/8-inch Taper per Foot

Deliberate difference in taper between the plug and the tapped hole. Ideal for use in assemblies where clearance is limited and in hydraulic lines near

moving parts. Designed for use in hard materials and in thick-walled sections as well as for normal plug applications.

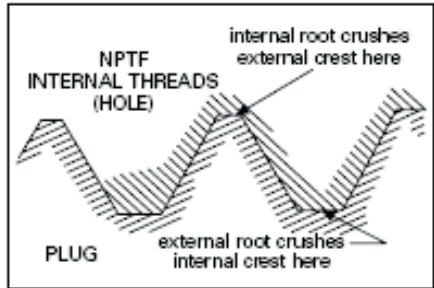
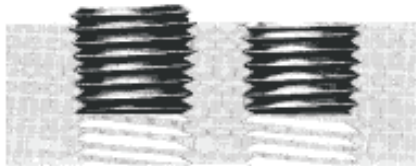
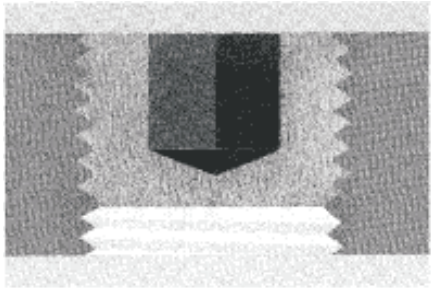

High pressure seal— Achieved through metal-to-metal contact at the large end of the plug. High load placed on the few mating threads near the top of the hole.

Flush seating— Design of LEVEL-SEAL plug permits seating within half a pitch in a normally tapped hole. Conventional plugs have the greater tolerance of a full pitch and usually protrude above the surface.

PTF fully formed Dryseal threads designed to achieve seal in tapped holes without need for sealing compounds.

PTFE/TEFLON Coated LEVEL-SEAL Type

Typical thickness is 0.0005-inch LEVEL-SEAL precision coated with tough, corrosion-resistant PTFE/TEFLON. Installation of the new plugs is faster with

of tapes or sealing compounds, even with liquids of very low viscosity. Unbrako Laboratories have tested these plugs with surges up to 13,500 psi 8 times in 5 minutes, then held peak pressure for 6 full hours without trace of leakage.

combination of extra hardness and abrasion resistance which permit reuse up to 5 times without appreciable loss of seal.

The coating is serviceable to +450°F without deterioration.

the coating of PTFE/TEFLON which acts as a lubricant as well as seal. Power equipment can be used to install the smaller sizes instead of the manual wrenching required by higher torques of uncoated plugs. Suited for in assembly line production.

Flush seating improves appearance and adds safety. LEVEL-SEAL plugs seat flush because of a combination of (1) gaging procedures, and (2) a deliberate difference in taper between the plug and a normally tapped NPTF hole. (The taper of the plug is 7/8" per foot, while that of the hole is 3/4" per foot.)

Temperatures lower than -100° F require the use of stainless steel plugs. These are available in the same range of sizes as the alloy steel plugs.

With no tape or sealing compound involved, there is no danger of foreign matter entering and contaminating the system or equipment. The coating reduces any tendency of the plug to "freeze" in the hole because of rust or corrosion.

Higher hydraulic and pneumatic working pressures can be effectively sealed. Seal is effective without use

PTFE/TEFLON was selected for the coating material because of its

APPLICATION DATA – LEVEL-SEAL and LEVEL-SEAL with PTFE/TEFLON

nom. size	threads per inch	recommended hole diameter		tapping information tap projection thru L ₁ ring		Imperfect threads allowable	tap* drill size	recommended torque (inch-lbs.) alloy steel
		max.	min.	max.	min.			
1/16	27	.2374	.2334	.375	.250	4	15/64	150
1/8	27	.3271	.3271	.375	.250	4	21/64	250
1/4	18	.4249	.4209	.521	.397	4	27/64	600
3/8	18	.5655	.5615	.516	.392	4	9/16	1200
1/2	14	.6905	.6865	.641	.517	4	11/16	1800
3/4	14	.8836	.8896	.627	.503	4	57/64	3000
1	11 1/2	1.280	1.1240	.772	.584	4	1 1/8	4200
1 1/4	11 1/2	1.4794	1.4754	.780	.592	4	37.5mm	5400
1 1/2	11 1/2	1.7165	1.7116	.793	.605	4	43.5mm	6900
2	11 1/2	2.1905	2.8165	.761	.573	4	2 3/16	8500

*For taper thread (using tapered reamer). For tap drill size (without using tapered reamer) see table and corresponding comment on page 26.

**Maximum for PTFE/TEFLON-coated but can be reduced as much as 60% in most applications.

DOWEL PINS ■ Dimensions ■ Application Data

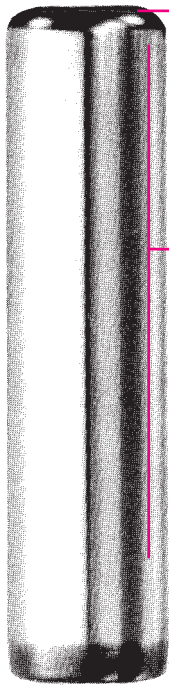

Formed ends resist chipping

Surface hardness: Rockwell "C" 60 minimum

Surface finish: 8 microinch maximum

Core hardness: Rockwell "C" 50-58

Case depth: .020-inch minimum

Shear strength: 150,000 psi (calculated based on conversion from hardness)

Heat treated alloy steel for strength and toughness

Material, Heat Treatment, Dimensions: ASME B18.8.2

.0002 – inch oversize typically used for first installation.

.0010 – inch oversize typically used after hole enlarges.

Installation Warning – Do not strike. Use safety shield or glasses when pressing chamfered end in first.

Single shear load calculated as $150,000 \text{ psi} \times \pi (\text{nom. } A)^2 \div 4$

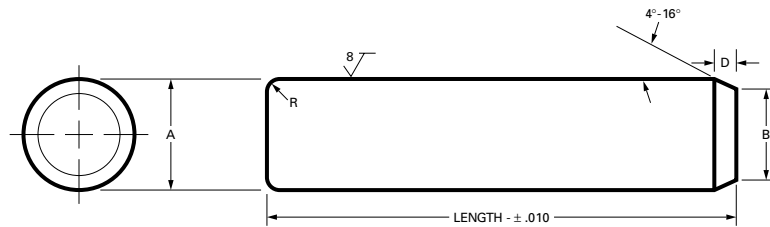

DIMENSIONS and APPLICATION DATA

nom.	A				B	D	R	calculated single shear strength (pounds)	recommended hole size (.0002 over nom.)	
	.0002 over nom.		.001 over nom.						max.	min.
	max.	min.	max.	min.						
1/16	.0628	.0626	.0636	.0634	.058	.016	.008	465	.0625	.0620
3/32	.0941	.0939	.0949	.0947	.089	.018	.012	1,035	.0937	.0932
1/8	.1253	.1251	.1261	.1259	.120	.022	.016	1,845	.1250	.1245
5/32	.1565	.1563	.1573	.1571	.150	.022	.020	2,880	.1562	.1557
3/16	.1878	.1876	.1886	.1884	.180	.023	.023	4,140	.1875	.1870
1/4	.2503	.2501	.2511	.2509	.240	.031	.031	7,370	.2500	.2495
5/16	.3128	.3126	.3136	.3134	.302	.034	.039	11,500	.3125	.3120
3/8	.3753	.3751	.3761	.3759	.365	.038	.047	16,580	.3750	.3745
7/16	.4378	.4376	.4386	.4384	.424	.047	.055	22,540	.4375	.4370
1/2	.5003	.5001	.5011	.5009	.486	.047	.063	29,460	.5000	.4995
9/16	.5628	.5626	.5636	.5634	.548	.047	.070	37,270	.5625	.5620
5/8	.6253	.6251	.6261	.6259	.611	.047	.078	46,020	.6250	.6245
3/4	.7503	.7501	.7511	.7509	.735	.059	.094	66,270	.7500	.7495
7/8	.8753	.8751	.8761	.8759	.860	.059	.109	90,190	.8750	.8745
1	1.0003	1.0001	1.0011	1.0009	.980	.059	.125	117,810	1.0000	.9995

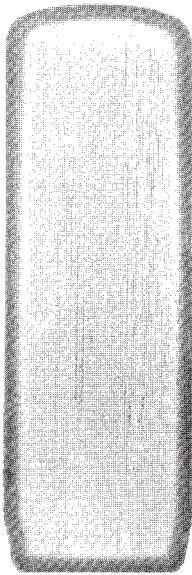

Continuous grain flow resists chipping of ends. Precision heat treated for greater strength and surface hardness.

Chamfered end provides easier insertion in hole. Surface finish to 8 microinch maximum.

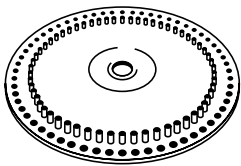
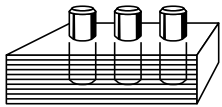
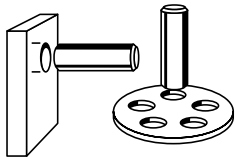
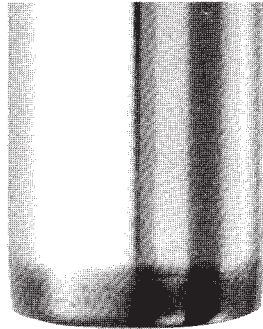

APPLICATIONS

Widely used as plug gages in various production operations, and as guide pins, stops, wrist pins, hinges and shafts. Also used as position locators on indexing machines, for aligning parts, as feeler gages in assembly work, as valves and valve plungers on hydraulic equipment, as fasteners for laminated sections and machine parts, and as roller bearings in casters and truck wheels.

PULL-OUT DOWEL PINS ■ Dimensions ■ Application Data

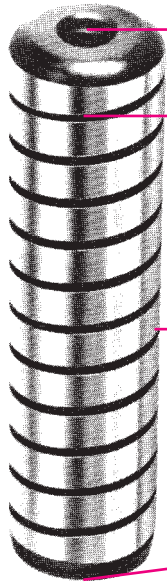

Tapped hole for easy pull-out (ANSI B1.1)

Exclusive spiral grooves afford uniform relief for insertion and removal, reduce chances of hole-scoring

Surface hardness-Rockwell C60 minimum

Surface finish-8 microinch maximum

Core hardness-Rockwell C 50-58

Shear strength: 150,000 psi (calculated based on conversion from hardness)

Heat treated alloy steel for strength and toughness

Held to precise tolerance - .0002-inch on diameter and roundness to 50 millionths of an inch (T.I.R.)

Formed ends resist chipping

Material and Heat Treatment: ASME B18.8.2

Single shear load calculated as $150,000 \text{ psi} \times \pi (\text{nom. } A)^2 \div 4$

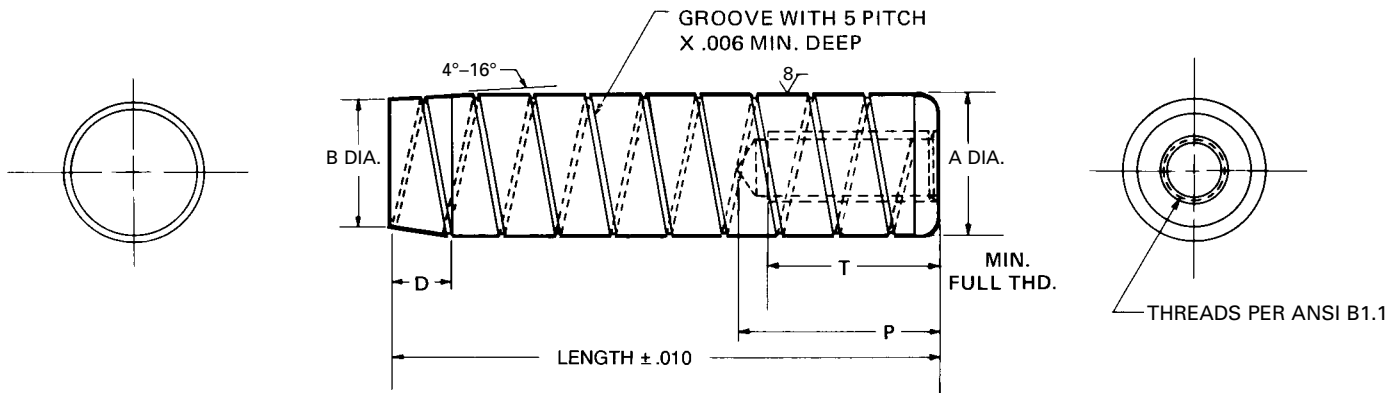

DIMENSIONS and APPLICATION DATA

size nom.	thread size	B max.	A		D min.	P note 1 max.	T min.	X note 2	calculated single shear strength (pounds)	recommended hole diameter	
			max.	min.						max.	min.
1/4	#8-32 UNC-2B	.237	.2503	.2501	.031	.500	.212	7/16	7,370	.2500	.2495
5/16	#10-32 UNF-2B	.302	.3128	.3126	.034	.625	.243	1/2	11,500	.3125	.3120
3/8	#10-32 UNF-2B	.365	.3753	.3751	.038	.625	.243	9/16	16,580	.3750	.3745
7/16	#10-32 UNF-2B	.424	.4378	.4376	.047	.625	.243	5/8	22,540	.4315	.4370
1/2	1/4-20 UNC-2B	.486	.5003	.5001	.047	.750	.315	3/4	29,460	.5000	.4995
5/8	1/4-20 UNC-2B	.611	.6253	.6251	.047	.750	.315	3/4	46,020	.6250	.6245
3/4	5/16-18 UNC-2B	.735	.7503	.7501	.059	.875	.390	13/16	66,270	.7500	.7495
7/8	3/8-16 UNC-2B	.860	.8753	.8751	.059	.875	.390	13/16	90,190	.8750	.8745
1	3/8-16 UNC-2B	.980	1.0003	1.0001	.059	.875	.390	13/16	117,810	1.0000	.9995

NOTES

1. Lengths equal to or shorter than "P" max. values may be drilled through.

2. Point angle (approx.) 5° on point for lengths equal to or longer than X. For shorter lengths, use 15° angle.

PULL-OUT DOWEL PINS

Dimensions ■ Application Data

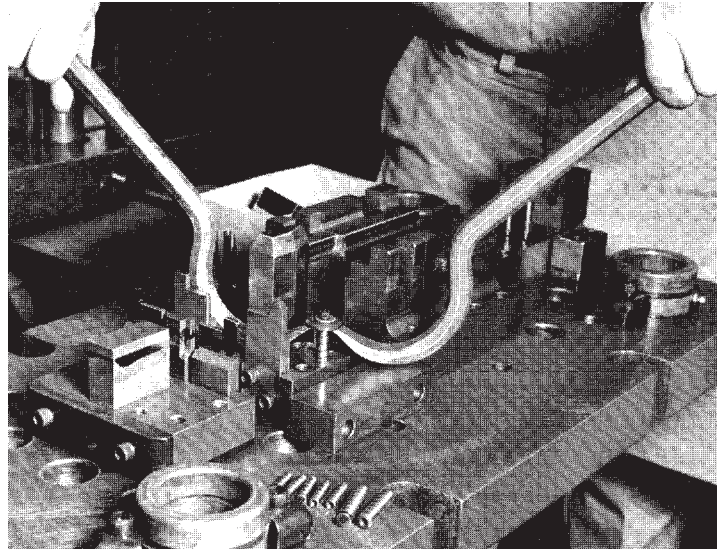

5 WAYS TO SAVE

UNBRAKO Pull-Out Dowel Pins are easier, more accurate and more economical than "do-it-yourself" modifications of standard dowels. They save you money FIVE ways:

1. YOU SAVE COST OF SEPARATE KNOCK-OUT HOLES IN BLIND HOLES WHERE PINS MUST BE REMOVED.

UNBRAKO pull-out pins are easy to install in blind holes, easy to remove. Exclusive spiral grooves release trapped air for insertion or removal without danger of hole-scoring.

2. YOU MUST SAVE COST OF NEW PINS EACH TIME DIE IS SERVICED OR DISMANTLED.

UNBRAKO pull-out dowel pins are reusable. The hole tapped in one end for a removal screw or threaded "puller" makes it easy and fast to remove the pin without damage to pin or hole, permits repeated re-use.

3. YOU SAVE MONEY IN REDUCED DOWNTIME AND LOSS OF PRODUCTION

UNBRAKO pull-out dowel pins speed up die servicing and reworking. You can remove them without turning the die over, and you can take out individual sections of the die for rework or service without removing entire die assembly from the press.

4. YOU SAVE MODIFICATIONS COSTS, YOU AVOID HEADACHES AND YOU SAVE YOUR SKILLED PEOPLE FOR PROFITABLE WORK.

UNBRAKO pull-out dowel pins have tapped holes and relief grooves built in. Time-consuming "do-it-yourself" modification of standard pin eliminated. No need for annealing (to make pins soft enough to drill and tap) and re-hardening, which can result in damage to finish, and in inaccuracies and distortion.

5. YOU SAVE TIME AND MONEY BECAUSE OF THIS QUALITY "REPEATABILITY." NO SPECIAL PREPARATION OF INDIVIDUAL HOLES NEEDED-YOU CAN BE SURE OF ACCURATE FIT EVERY TIME.

UNBRAKO pull-out dowel pins are identical and interchangeable with standard **UNBRAKO** dowels. They have the same physical, finish, accuracy and tolerances. And they are consistently uniform. Their exclusive spiral relief grooves provide more uniform relief than other types of removable pins, assuring more uniform pull-out values.

You don't need any special tools to remove **UNBRAKO** pull-out dowels-just an ordinary die hook and a socket head cap or button head socket screw.

HEX KEYS ■ Dimensions ■ Mechanical Properties ■ Screw Size Table

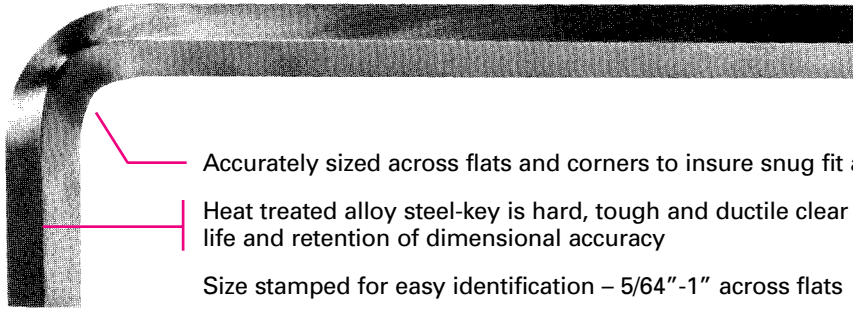

Accurately sized across flats and corners to insure snug fit and full wall contact

Heat treated alloy steel-key is hard, tough and ductile clear through for longer life and retention of dimensional accuracy

Size stamped for easy identification – 5/64"-1" across flats

Square cut end engages the socket full depth for better tightening of screw

GGG-K-275. ANSI B18.3

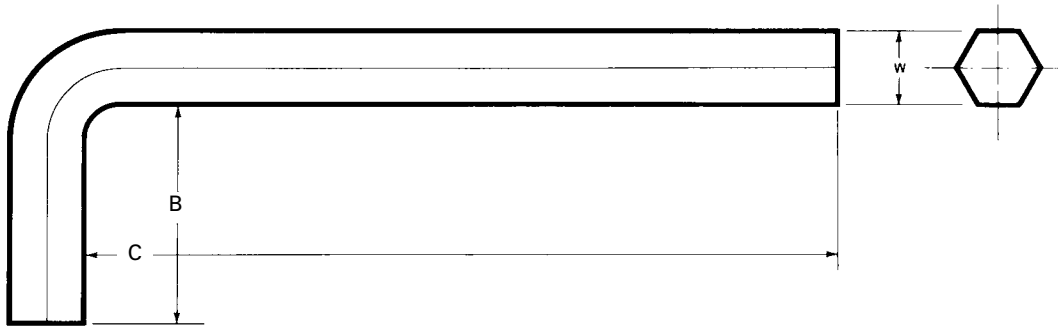

DIMENSIONS

MECHANICAL PROPERTIES

key size W		dash number size page 87	C length of long arm				B length of short arm		torsional shear strength inch-lbs. min.	torsional yield inch-lbs. min.
max.	min.		short series		long series		max.	min.		
			max.	min.	max.	min.				
.028	.0275	1	1.312	1.125	2.688	2.500	.312	.125	1.1	.9
.035	.0345	2	1.312	1.125	2.766	2.578	.438	.250	2.3	2.0
.050	.049	3	1.750	1.562	2.938	2.750	.625	.438	6.5	5.6
1/16	.0615	4	1.844	1.656	3.094	2.906	.656	.469	12.2	10.5
5/64	.0771	5	1.969	1.781	3.281	3.094	.703	.516	25	21
3/32	.0927	6	2.094	1.906	3.469	3.281	.750	.562	43	35
7/64	.1079	7	2.219	2.031	3.656	3.469	.797	.609	68	60
1/8	.1235	8	2.344	2.156	3.844	3.656	.844	.656	98	85
9/64	.1391	9	2.469	2.281	4.031	3.844	.891	.703	146	125
5/32	.1547	10	2.594	2.406	4.219	4.031	.938	.750	195	165
3/16	.1860	11	2.844	2.656	4.594	4.406	1.031	.844	342	295
7/32	.2172	12	3.094	2.906	4.969	4.781	1.125	.938	535	460
1/4	.2485	13	3.344	3.156	5.344	5.156	1.219	1.031	780	670
5/16	.3110	14	3.844	3.656	6.094	5.906	1.344	1.156	1,600	1,370
3/8	.3735	15	4.344	4.156	6.844	6.656	1.469	1.281	2,630	2,260
7/16	.4355	16	4.844	4.656	7.594	7.406	1.594	1.406	4,500	3,870
1/2	.4975	17	5.344	5.156	8.344	8.156	1.719	1.531	6,300	5,420
9/16	.5600	18	5.844	5.656	9.094	8.906	1.844	1.656	8,900	7,650
5/8	.6225	19	6.344	6.156	9.844	9.656	1.969	1.781	12,200	10,500
3/4	.7470	20	7.344	7.156	11.344	11.156	2.219	2.031	19,500	16,800
7/8	.8720	21	8.344	8.156	12.844	12.656	2.469	2.281	29,000	24,900
1	.9970	22	9.344	9.156	14.344	14.156	2.719	2.531	43,500	37,400
1 1/4	1.243	23	11.500	11.000			3.250	2.750	71,900	62,500
1 1/2	1.493	24	13.500	13.000			3.750	3.250	124,000	108,000
1 3/4	1.743	25	15.500	15.000			4.250	3.750	198,000	172,000
2	1.993	26	17.500	17.000			4.750	4.250	276,000	240,000

HEXAGON KEYS

Why UNBRAKO keys tighten socket screws tighter, safely

An UNBRAKO key is not an ordinary hexagon key – it is a precision internal wrenching tool of great strength and ductility. With an UNBRAKO key, far more tightening torque than is needed can be applied without damaging the screw or the key, and it can be done safely. This is an important feature, especially true of the smaller sizes (5/32" and under) which are normally held in the hand.

Photographs of a destruction test show what we mean. Under excessive torque a 5/64" UNBRAKO key twists but does not shear until a torque has been reached that is approximately 20% greater than can be applied with an ordinary key. At this point it shears off clean, flush with the top of the socket, leaving no jagged edge to gash a hand.

Still the UNBRAKO screw has not been harmed. The broken piece of the key is not wedged into the socket. It can be lifted out with a small magnet, convincing proof that the socket has not been reamed or otherwise damaged.

NOTE: The use of an extension in these illustrations is for demonstration purposes only. The manufacturer does not recommend the use of extensions with any hex key product under normal conditions.

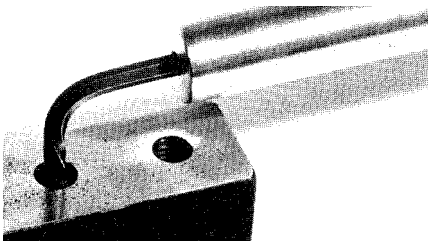

A 5/64" UNBRAKO key will twist up to 180° without weakening.

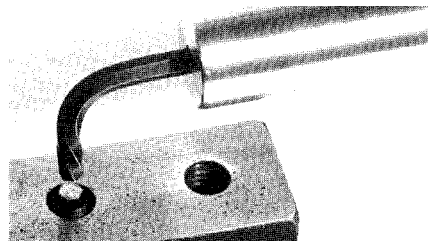

Twisted to about 270°, the key shears off clean. Note the extension bar illustrated for test purposes only.

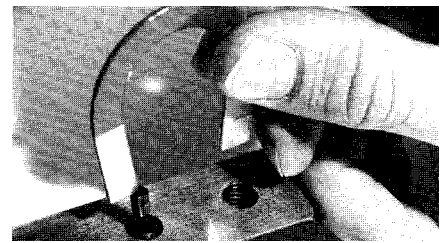

The socket hasn't been reamed or damaged. Broken section can be lifted out with a magnet.

SCREW SIZE SELECTOR TABLE

	1960 Series socket head cap screws	button head screws	flat head screws	shoulder screws	low heads and socket set screws	pressure* plugs
	#0	#0 #1,#2	#0 #1,#2		#0 #1, #2 #3, #4	
	#1 #2,#3 #4,#5	#3,#4 #5,#6 #8	#3, #4 #5,#6 #8		#5,#6 #8 #10	
	#6 #8	#10	#10	1/4	1/4	
	#10 1/4	1/4 5/16 3/8	1/4 5/16 3/8	5/16 3/8	5/16 3/8 7/16	1/16 1/8
	5/16 3/8 7/16,1/2	1/2 5/8	7/16 1/2, 9/16 5/8	1/2 5/8 3/4	1/2 5/8 3/4	1/4 3/8 1/2
	9/16 5/8		3/4 7/8	7/8, 1	7/8 1, 1/8	3/4
	3/4 7/8,1 1 1/8, 1 1/4		1	1 1/4 1 1/2	1 1/4, 1 3/8 1 1/2	1 1-1/4, 1-1/2
	1 3/8, 1 1/2 1 3/4 2			1 3/4 2		1/2,2
	2 1/4, 2 1/2 2 3/4					

NOTES

Material: ANSI B18.3, alloy steel

Heat treat: Rc 47-57

THREAD CONVERSION CHARTS

DIAMETER/THREAD PITCH COMPARISON

INCH SERIES			METRIC			
Size	Dia. (In.)	TPI	Size	Dia.(In.)	Pitch (mm)	TPI (Approx)
#0	0.060	80				
			M1.6	0.063	0.35	74
#1	0.073	64				
			M2	0.079	0.4	64
#2	0.096	56				
			M2.5	0.098	0.45	56
#3	0.099	48				
#4	0.112	40				
			M3	0.118	0.5	51
#5	0.125	40				
#6	0.138	32				
			M4	0.157	0.7	36
#8	0.164	32				
#10	0.190	24				
			M5	0.196	0.8	32
			M6	0.236	1.00	25
1/4	0.250	20				
5/16	0.312	18				
			M8	0.315	1.25	20
3/8	0.375	16				
			M10	0.393	1.5	17
7/16	0.437	14				
			M12	0.472	1.75	14.5
1/2	0.500	13				
			M14	0.551	2	12.5
5/8	0.625	11				
			M16	0.63	2	12.5
3/4	0.750	10				
			M20	0.787	2.5	10
7/8	0.875	9				
			M24	0.945	3	8.5
1	1.000	8				
			M27	1.063	3	8.5

TABLE OF CONTENTS

UNBRAKO® Socket Screw Products (Metric)

	Page
Metric Standards	36
Socket Head Cap Screws	
Standards – Alloy Steel	38
Low Heads – Alloy Steel	46
Flat Head Socket Screws	
Alloy Steel	40
Button Head Socket Screws	
Alloy Steel	41
Shoulder Screws	
Alloy Steel	42
Dowel Pins	
Standards – Alloy Steel	43
Socket Set Screws	
Alloy Steel	44
Low Head Cap Screws	
Low Heads – Alloy Steel	46
Hex Keys	
Alloy Steel	47
ISO Tolerances	48
Conversion Chart	50

UNBRAKO Metric Fasteners

UNBRAKO Metric Fasteners are the strongest off-the-shelf threaded fasteners you can buy. Their exclusive design features and closely controlled manufacturing processes insure the dimensional accuracy, strength and fatigue resistance needed for reliability in today's advanced technology. They are manufactured with the same methods and features as their inch-series counterpart.

Strength

UNBRAKO metric socket head cap screws are made into property class 12.9 with a minimum ultimate tensile strength of 1300 or 1250 MPa depending on screw diameter. Precision in manufacturing and careful control in stress areas insure strength in such critical areas as heads, sockets, threads, fillets, and bearing areas.

When you purchase UNBRAKO metric socket screw products, you can be sure that they meet or exceed the strength levels of all current standards, including the three most common-ANSI, ISO and DIN. Unbrako is represented on several ASME, ANSI, ASTM and ISO committees.

- ANSI (American National Standards Institute) documents are published by ASME (The American Society of Mechanical Engineers) and are familiar to almost all users of socket screw products in the U.S.A.
- ASTM (American Society for Testing and Materials). Many ANSI documents list dimensional information but refer to ASTM specifications for materials, mechanical properties, and test criteria.

- ISO (International Standards Organization) is a standards group comprising 70 member nations. Its objective is to provide standards that will be completely universal and common to all countries subscribing.

- DIN (Deutsche Industries Normen) is the German standards group.

NOTE: The proper tightening of threaded fasteners can have a significant effect on their performance.

A WARNING TO METRIC FASTENER USERS

Metric socket cap screws are NOT sold in a single strength level like U.S. inch socket screws.

Property Class	General Material	Strength Level, UTS min. MPa (KSI)
	International Standards Organization, ISO	
Property Class 8.8	Carbon Steel	800 (116) < M16 830 (120) ≥ M16
Property Class 10.9	Alloy Steel	1040 (151)
Property Class 12.9	Alloy Steel	1220 (177)
USA Standards ASTM A574M	Alloy Steel	1220 (177)
Unbrako Standards ASTM A574M	Alloy Steel	1300 (189) ≤ M16 1250 (181) > M16

STANDARDS

The use of metric fasteners in the worldwide market has led to the creation of many standards. These standards specify the fastener requirements: dimensions, material, strength levels, inspection, etc. Different standards are the responsibility of various organizations and are not always identical. Unbrako supplies metric fasteners for maximum interchangeability with all standards. This Engineering Guide was published with the most current values, which are however subject to change by any standards organization at any time.

METRIC SOCKET HEAD CAP SCREWS

Dimensions

Threads: ANSI B1.13M, ISO 261, ISO 262 (coarse series only)
Property Class: 12.9-ISO 898/1

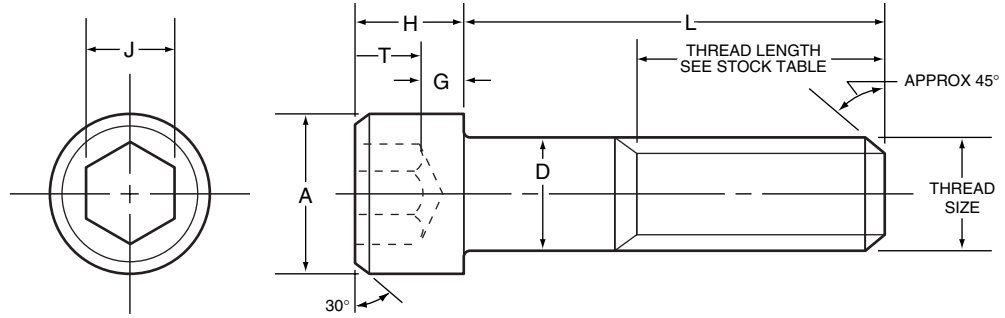

NOTES

- Material:** ASTM A574M, DIN ENISO4762-alloy steel
- Hardness:** Rc 38-43
- Tensile Stress:** 1300 MPa thru M16 size.
1250 MPa over M16 size.
- Yield Stress:** 1170 MPa thru M16 size.
1125 MPa over M16 size.
- Thread Class:** 4g 6g

LENGTH TOLERANCE

nominal screw length	nominal screw diameter		
	M1.6 thru M10	M12 thru M20	over 20
	tolerance on lgth., mm		
Up to 16 mm, incl.	±0.3	±0.3	-
Over 16 to 50 mm, incl.	±0.4	±0.4	±0.7
Over 50 to 120 mm, incl.	±0.7	±1.0	±1.5
Over 120 to 200 mm, incl.	±1.0	±1.5	±2.0
Over 200 mm	±2.0	±2.5	±3.0

DIMENSIONS

MECHANICAL PROPERTIES

APPLICATION DATA

thread size nom.	pitch	A max.	D max.	H max.	J nom.	G min.	T min.	UTS min. MPa	tensile strength min.		single shear strength of body min.		recommended ** seating torque plain finish	
									kN	lbs.	kN	lbs.	N-m	in-lbs.
M1.6	0.35	3.0	1.6	1.6	1.5	0.54	0.80	1300	1.65	370	1.57	352.5	0.29	2.6
M2	0.40	3.8	2.0	2.0	1.5	0.68	1.0	1300	2.69	605	2.45	550	0.60	5.3
M2.5	0.45	4.5	2.5	2.5	2.0	0.85	1.25	1300	4.41	990	3.83	860	1.21	11
M3	0.5	5.5	3.0	3.0	2.5	1.02	1.5	1300	6.54	1,470	5.5	1240	2.1	19
M4	0.7	7.0	4.0	4.0	3.0	1.52	2.0	1300	11.4	2,560	9.8	2,205	4.6	41
M5	0.8	8.5	5.0	5.0	4.0	1.90	2.5	1300	18.5	4,160	15.3	3,445	9.5	85
M6	1.0	10.0	6.0	6.0	5.0	2.28	3.0	1300	26.1	5,870	22.05	4,960	16	140
M8	1.25	13.0	8.0	8.0	6.0	3.2	4.0	1300	47.6	10,700	39.2	8,800	39	350
M10	1.5	16.0	10.0	10.0	8.0	4.0	5.0	1300	75.4	17,000	61	13,750	77	680
M12	1.75	18.0	12.0	12.0	10.0	4.8	6.0	1300	110	24,700	88	19,850	135	1,200
*(M14)	2.0	21.0	14.0	14.0	12.0	5.6	7.0	1300	150	33,700	120	27,000	215	1,900
M16	2.0	24.0	16.0	16.0	14.0	6.4	8.0	1300	204	45,900	157	35,250	330	2,900
M20	2.5	30.0	20.0	20.0	17.0	8.0	10.0	1250	306	68,800	235.5	53,000	650	5,750
M24	3.0	36.0	24.0	24.0	19.0	9.6	12.0	1250	441	99,100	339	76,500	1100	9,700
*M30	3.5	45.0	30.0	30.0	22.0	12.0	15.0	1250	701	158,000	530	119,000	2250	19,900
*M36	4.0	54.0	36.0	36.0	27.0	14.4	18.0	1250	1020	229,000	756	171,500	3850	34,100
*M42	4.5	63.0	42.0	42.0	32.0	16.8	21.0	1250	1400	315,000	1040	233,500	6270	55,580
*M48	5.0	72.0	48.0	48.0	36.0	19.2	24.0	1250	1840	413,000	1355	305,000	8560	75,800

All dimensions in millimeters.

Sizes in brackets not preferred for new designs.

*Non-stock diameter.

**Torque calculated in accordance with VDI 2230, "Systematic Calculation of High Duty Bolted Joints," to induce approximately 800 MPa stress in screw threads. Torque values listed are for plain screws. (See Note, page 1.)

SOCKET HEAD CAP SCREWS ■ Metric ■ Body and Grip Lengths

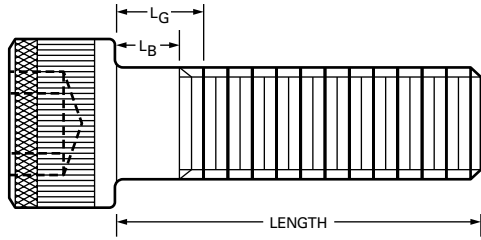

L_G is the maximum grip length and is the distance from the bearing surface to the first complete thread.

L_B is the minimum body length and is the length of the unthreaded cylindrical portion of the shank.

BODY and GRIP LENGTHS

BODY AND GRIP LENGTH DIMENSIONS FOR METRIC SOCKET HEAD CAP SCREWS

Nominal Size	M1.6		M2		M2.5		M3		M4		M5		M6		M8		M10		M12		M14		M16		M20		M24		
	L_G	L_B	L_G	L_B	L_G	L_B	L_G	L_B	L_G	L_B	L_G	L_B	L_G	L_B	L_G	L_B	L_G	L_B	L_G	L_B	L_G	L_B	L_G	L_B	L_G	L_B	L_G	L_B	
20	4.8	3.0	4.0	2.0																									
25	9.8	8.0	9.0	7.0	8.0	5.7	7.0	4.5																					
30	14.8	13.0	14.0	12.0	13.0	10.7	12.0	9.5	10.0	6.5																			
35	19.0	17.0	18.0	15.7	17.0	14.5	15.0	11.5	13.0	9.0	11.0	6.0															
40	24.0	22.0	23.0	20.7	22.0	19.5	20.0	16.5	18.0	14.0	16.0	11.0															
45	28.0	25.7	27.0	24.5	25.0	21.5	23.0	19.0	21.0	16.0	17.0	10.7													
50	33.0	30.7	32.0	29.5	30.0	26.5	28.0	24.0	26.0	21.0	22.0	15.7	18.0	10.5											
55	37.0	34.5	35.0	31.5	33.0	29.0	31.0	26.0	27.0	20.7	23.0	15.5											
60	42.0	39.5	40.0	36.5	38.0	34.0	36.0	31.0	32.0	25.7	28.0	20.5	24.0	15.2									
65	47.0	44.5	45.0	41.5	43.0	39.0	41.0	36.0	37.0	30.7	33.0	25.5	29.0	20.2	25.0	15.0							
70	50.0	46.5	48.0	44.0	46.0	41.0	42.0	35.7	38.0	30.5	34.0	25.2	30.0	20.0	26.0	16.0					
80	60.0	56.5	58.0	54.0	56.0	51.0	52.0	45.7	48.0	40.5	44.0	35.2	40.0	30.0	36.0	26.0					
90	68.0	64.0	66.0	61.0	62.0	55.7	58.0	50.5	54.0	45.2	50.0	40.0	46.0	36.0	38.0	25.5			
100	78.0	74.0	76.0	71.0	72.0	65.7	68.0	60.5	64.0	55.2	60.0	50.0	56.0	46.0	48.0	35.5	40.0	25.0	
110	86.0	81.0	82.0	75.7	78.0	70.5	74.0	65.2	70.0	60.0	66.0	56.0	58.0	45.5	50.0	35.0
120	96.0	91.0	92.0	85.7	88.0	80.5	84.0	75.2	80.0	70.0	76.0	66.0	68.0	55.5	60.0	45.0
130	102.0	95.7	98.0	90.5	94.0	85.2	90.0	80.0	86.0	76.0	78.0	65.5	70.0	55.0
140	112.0	105.7	108.0	100.5	104.0	95.2	100.0	90.0	96.0	86.0	88.0	75.5	80.0	65.0
150	122.0	115.7	118.0	110.5	114.0	105.2	110.0	100.0	106.0	96.0	98.0	85.5	90.0	75.0
160	132.0	125.7	128.0	120.5	124.0	115.2	120.0	110.0	116.0	106.0	108.0	95.5	100.0	85.0
180	148.0	140.5	144.0	135.2	140.0	130.0	136.0	126.0	128.0	115.5	120.0	105.0
200	168.0	160.5	164.0	155.2	160.0	150.0	156.0	146.0	148.0	135.5	140.0	125.0
220	184.0	175.2	180.0	170.0	176.0	166.0	168.0	155.5	160.0	145.0
240	204.0	195.2	200.0	190.0	196.0	186.0	188.0	175.5	180.0	165.0
260	220.0	210.0	216.0	206.0	208.0	195.5	200.0	185.0	
300	256.0	246.0	248.0	235.5	240.0	225.0	

SOCKET HEAD CAP SCREWS (METRIC SERIES)

PER ASME/ANSI B18.3.1M-1986

METRIC SOCKET FLAT HEAD CAP SCREWS

Dimensions

Threads: ANSI B1.13M, ISO 262 (coarse series only)

Applicable or Similar Specification: DIN ENISO10642

General Note: Flat, countersunk head cap screws and button head cap screws are designed and recommended for moderate fastening applications: machine guards, hinges, covers, etc. They are not suggested for use in critical high strength applications where socket head cap screws should be used.

NOTES

1. **Material:** ASTM F835M
2. **Dimensions:** B18.3.5M
3. **Property Class:** 12.9
4. **Hardness:** Rc 38-43 (alloy steel)
5. **Tensile Stress:** 1040MPa
6. **Shear Stress:** 630 MPa
7. **Yield Stress:** 945 MPa
8. **Sizes:** For sizes up to and including M20, head angle shall be 92°/90°. For larger sizes head angle shall be 62°/60°.
9. **Thread Class:** 4g 6g

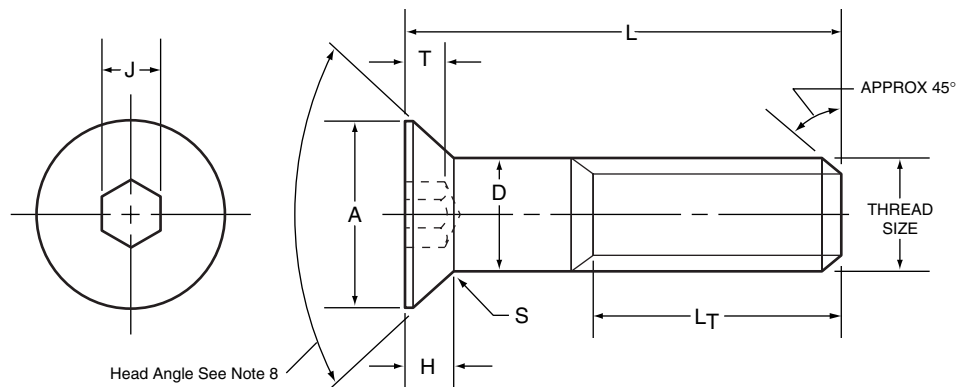

LENGTH TOLERANCE

nominal screw length	nominal screw diameter	
	M3 thru M24	
	tolerance on lgth., mm	
Up to 16 mm, incl.	±0.3	
Over 16 to 60 mm, incl.	±0.5	
Over 60 mm	±0.8	

DIMENSIONS

APPLICATION DATA

nom. thread size	pitch	A max.***	D max.	H ref.	T min.	S ref.	LT min.	J nom.	recommended seating torque**	
									plain	
									N-m	in-lbs.
M3	0.5	6.72	3	1.7	1.10	0.50	18	2	1.2	11
M4	0.7	8.96	4	2.3	1.55	0.70	20	2.5	2.8	25
M5	0.8	11.20	5	2.8	2.05	0.70	22	3	5.5	50
M6	1.0	13.44	6	3.3	2.25	0.85	24	4	9.5	85
M8	1.25	17.92	8	4.4	3.20	1.20	28	5	24	210
M10	1.50	22.40	10	5.5	3.80	1.50	32	6	47	415
M12	1.75	26.88	12	6.5	4.35	1.85	36	8	82	725
M16	2.00	33.60	16	7.5	4.89	1.85	44	10	205	1800
M20	2.50	40.32	20	8.5	5.45	1.85	52	12	400	3550
*M24	3.00	40.42	24	14.0	10.15	2.20	60	14	640	5650

All dimensions in millimeters.

***Maximum to theoretical sharp corner

*Non-stock Diameter

**Torque calculated to induce 420 MPa in the screw threads.

Torque values are for plain screws. (See Note, page 1.)

METRIC SOCKET BUTTON HEAD CAP SCREWS

Dimensions

Threads: ANSI B1.13M, ISO 262(coarse series only)

Similar Specifications: ISO 7380

General Note: Flat, countersunk head cap screws and button head cap screws are designed and recommended for moderate fastening applications: machine guards, hinges, covers, etc. They are not suggested for use in critical high strength applications where socket head cap screws should be used.

NOTES

- 1. Material:** ASTM F835M
- 2. Dimensions:** ANSI B18.3.4M
- 3. Property Class:** 12.9
- 4. Hardness:** Rc 38-43
- 5. Tensile Stress:** 1040 MPa
- 6. Shear Stress:** 630 MPa
- 7. Yield Stress:** 945 MPa
- Bearing surface of head square with body within 2°.
- 9. Thread Class:** 4g 6g

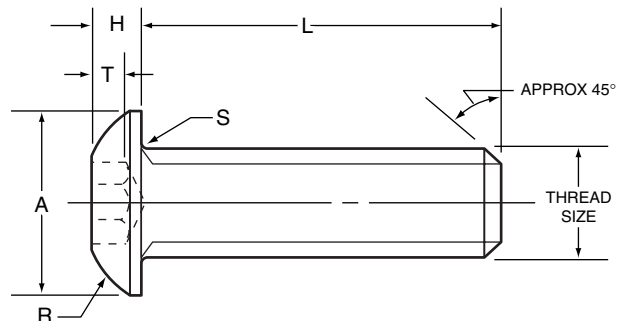
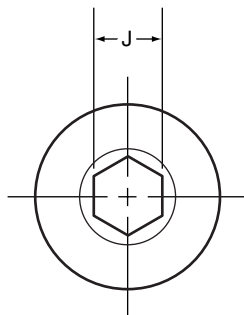
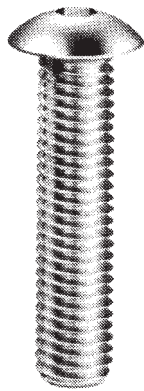

LENGTH TOLERANCE

nominal screw length	nominal screw diameter
	M3 thru M16
	tolerance on lgth., mm
Up to 16 mm, incl.	±0.3
Over 16 to 60 mm, incl.	±0.5
Over 60 mm	±0.8

DIMENSIONS

APPLICATION DATA

nom. thread size	pitch	A max.	H max.	T min.	R ref.	S ref.	J nom.	recommended seating torque**	
								plain	
								N-m	in-lbs.
M3	0.5	5.70	1.65	1.05	2.95	.35	2.0	1.2	11
M4	0.7	7.60	2.20	1.35	4.10	.35	2.5	2.8	25
M5	0.8	9.50	2.75	1.92	5.20	.45	3.0	5.5	50
M6	1.0	10.50	3.30	2.08	5.60	.45	4.0	9.5	85
M8	1.285	14.00	4.40	2.75	7.50	.45	5.0	24.0	210
M10	1.50	18.00	5.50	3.35	10.00	.60	6.0	47.0	415
M12	1.75	21.00	6.60	4.16	11.00	.60	8.0	82.0	725
*M16	2.0	28.00	8.60	5.20	15.00	.60	10.0	205.0	1800

All dimensions in millimeters.

*Non-stock Diameter

**Torque calculated to induce 420 MPa in the screw threads.

Torque values are for plain screws. (See Note, page 1.)

METRIC SOCKET HEAD SHOULDER SCREWS

Threads: ANSI B 1.13 M, ISO 262

Similar Specifications: ANSI B18.3.3M, ISO 7379, DIN 9841

NOTES

1. **Material:** ASTM A574M alloy steel
2. **Hardness:** Rc 36-43
3. **Tensile Stress:** 1100 MPa based on minimum thread neck area (G min.).
4. **Shear Stress:** 660 MPa
5. **Concentricity:** Body to head O.D. within 0.15 TIR when checked in a "V" block.
Body to thread pitch diameter within 0.1 TIR when checked at a distance of 5mm from the shoulder at the threaded end.
- Squareness, concentricity, parallelism, and bow of body to thread pitch diameter shall be within 0.05 TIR per centimeter of body length with a maximum of 0.5 when seated against the shoulder in a threaded bushing and checked on the body at a distance of 2.5 "D" from the underside of the head.
6. **Squareness:** The bearing surface of the head shall be perpendicular to the axis of the body within a maximum deviation of 2°.
7. **Thread Class:** 4g 6g

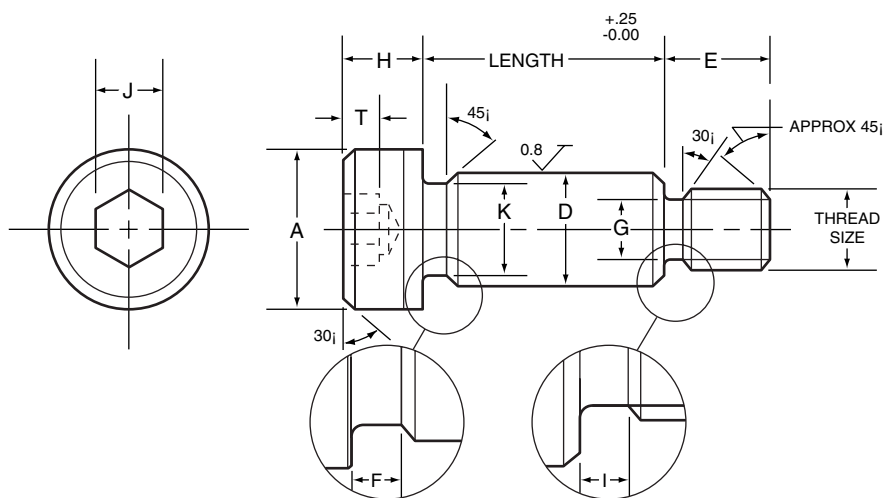
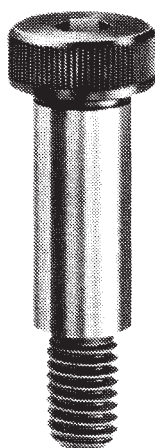

DIMENSIONS

APPLICATION DATA

nom. size	thread size	pitch	A max.	T min.	D*		K min.	H max.	G min.	F max.	I max.	E max.	J nom.	recommended seating torque**	
					max.	min.								N-m	in-lbs.
6	M5	0.8	10.00	2.4	6.0	5.982	5.42	4.50	3.68	2.5	2.40	9.75	3	7	60
8	M6	1.0	13.00	3.3	8.0	7.978	7.42	5.50	4.40	2.5	2.60	11.25	4	12	105
10	M8	1.25	16.00	4.2	10.0	9.978	9.42	7.00	6.03	2.5	2.80	13.25	5	29	255
12	M10	1.5	18.00	4.9	12.0	11.973	11.42	8.00	7.69	2.5	3.00	16.40	6	57	500
16	M12	1.75	24.00	6.6	16.0	15.973	15.42	10.00	9.35	2.5	4.00	18.40	8	100	885
20	M16	2.0	30.00	8.8	20.0	19.967	19.42	14.00	12.96	2.5	4.80	22.40	10	240	2125
24	M20	2.5	36.00	10.0	24.0	23.967	23.42	16.00	16.30	3.0	5.60	27.40	12	470	4160

All dimensions in millimeters.

**See Note, page 1.

*Shoulder diameter tolerance h8 (ISO R 286)

METRIC DOWEL PINS

Hardened and Ground ■ Dimensions

Applicable or Similar Specifications: ASME B18.8.5M, ISO 8734 or DIN 6325.

Installation warning: Dowel pins should not be installed by striking or hammering. Wear safety glasses or shield when pressing chamfered point end first.

NOTES

- Material:** ASME B18.8.5M-alloy steel
- Hardness:** Rockwell C60 minimum (surface)
Rockwell C 50-58 (core)
- Shear Stress:** Calculated values based on 1050 MPa.
- Surface Finish:** 0.2 micrometer maximum

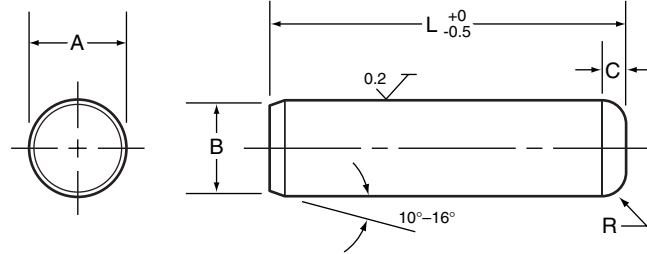

DIMENSIONS

APPLICATION DATA

nominal size	A pin diameter		B point diameter		C crown height max.	R crown radius min.	calculated single shear strength		recommended hole size	
	max.	min.	max.	min.			kN	pounds	max.	min.
3	3.008	3.003	2.9	2.6	0.8	0.3	7.4	1,670	3.000	2.987
4	4.009	4.004	3.9	3.6	0.9	0.4	13.2	2,965	4.000	3.987
5	5.009	5.004	4.9	4.6	1.0	0.4	20.6	4,635	5.000	4.987
6	6.010	6.004	5.8	5.4	1.1	0.4	29.7	6,650	6.000	5.987
8	8.012	8.006	7.8	7.4	1.3	0.5	52.5	11,850	8.000	7.987
10	10.012	10.006	9.8	9.4	1.4	0.6	82.5	18,550	10.000	9.987
12	12.013	12.007	11.8	11.4	1.6	0.6	119.0	26,700	12.000	11.985
16	16.013	16.007	15.8	15.3	1.8	0.8	211.0	47,450	16.000	15.985
20	20.014	20.008	19.8	19.3	2.0	0.8	330.0	74,000	20.000	19.983
25	25.014	25.008	24.8	24.3	2.3	1.0	515.0	116,000	25.000	24.983

All dimensions in millimeters.

METRIC SOCKET SET SCREWS ■ Knurled Cup Point and Plain Cup Point ■ Dimensions

Threads: ANSI B 1.13M, ISO 261, ISO 262
(coarse series only)

Grade: 45H

Applicable or Similar Specifications: ANSI B 18.3.6M,
ISO 4029, DIN 916, DIN 915, DIN 914, DIN 913

NOTES

- 1. Material:** ASTM F912M
- 2. Hardness:** Rockwell C45-53
- 3. Angle:** The cup angle is 135 maximum for screw lengths equal to or smaller than screw diameter. For longer lengths, the cup angle will be 124 maximum
- 4. Thread Class:** 6g

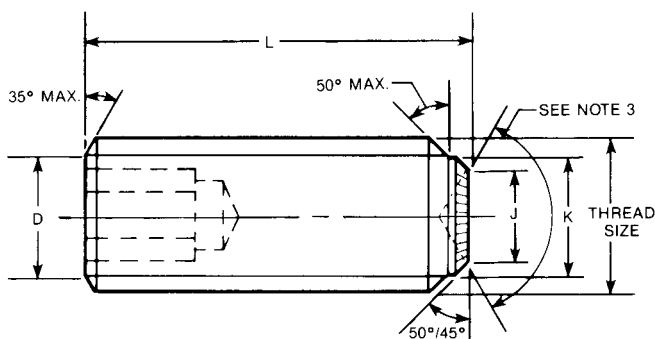

KNURLED CUP POINT

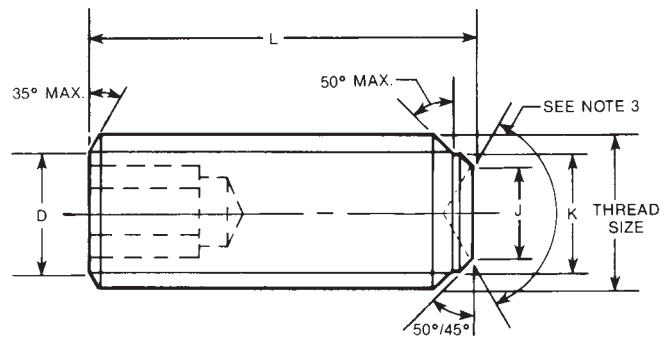

PLAIN CUP POINT

LENGTH TOLERANCE

nominal screw length	nominal screw diameter
	M1.6 thru M24
	tolerance on lgth., mm
Up to 12 mm, incl.	±0.3
Over 12 to 50 mm, incl.	±0.5
Over 50 mm	±0.8

DIMENSIONS

APPLICATION DATA

nom. thread size	pitch	D max.	J max.		K max.	L min. preferred		W nom.	recommended* seating torque	
			plain cup	knurled cup		plain cup	knurled cup		N-m	in-lbs.
MICROSIZE – Plain Cup Only										
M1.6	0.35	1.0	0.80	–	–	2.0	–	0.7	0.09	0.8
M2	0.40	1.32	1.00	–	–	2.5	–	0.9	0.21	1.8
M2.5	0.45	1.75	1.25	–	–	3.0	–	1.3	0.57	5.0
STANDARD SIZE – Knurled Cup Point Supplied Unless Plain Cup Point Is Specified										
M3	0.5	2.10	1.50	1.40	2.06	3.0	3.0	1.5	0.92	8.0
M4	0.7	2.75	2.00	2.10	2.74	3.0	3.0	2.0	2.2	19.0
M5	0.8	3.70	2.50	2.50	3.48	4.0	4.0	2.5	4.0	35.0
M6	1.0	4.35	3.00	3.30	4.14	4.0	5.0	3.0	7.2	64
M8	1.25	6.00	5.00	5.00	5.62	5.0	6.0	4.0	17.0	150.0
M10	1.5	7.40	6.00	6.00	7.12	6.0	8.0	5.0	33.0	290
M12	1.75	8.60	8.00	8.00	8.58	8.0	10.0	6.0	54.0	480
M16	2.0	12.35	10.00	10.00	11.86	12.0	14.0	8.0	134	1190
M20	2.5	16.00	14.00	14.00	14.83	16.0	18.0	10.0	237	2100
M24	3.0	18.95	16.00	16.00	17.80	20.0	20.0	12.0	440	3860

All dimensions in millimeters.

*Not applicable to screws with a length equal to or less than the diameter. See Note, page 1.

METRIC SOCKET SET SCREW

Flat Point, Cone Point, Dog Point Styles ■ Dimensions

REF. ISO 4026

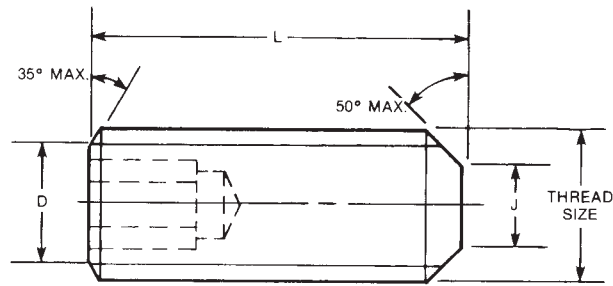
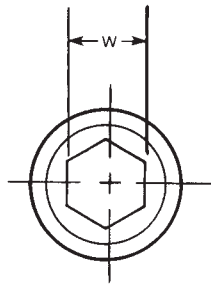

FLAT POINT

REF. ISO 4027

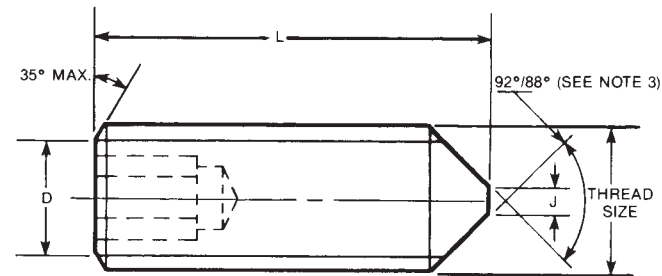
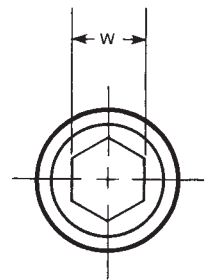

CONE POINT

REF. ISO 4028
ISO 7435

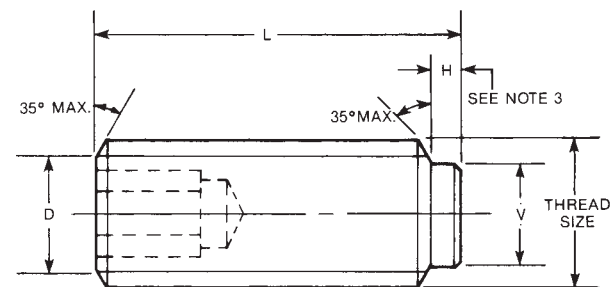
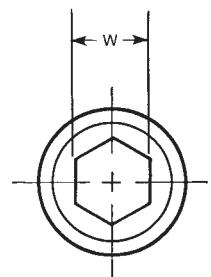

DOG POINT

DIMENSIONS

nom. thread size	pitch	D max.	flat point		cone point		dog point			
			J max.	L min. preferred	J max.	L min. preferred	H nom.		L min. preferred	V max.
							short lgth.	long lgth.		
M3	0.5	2.10	2.0	3.0	0.3	4.0	0.75	1.5	5.0	2.00
M4	0.7	2.75	2.5	3.0	0.4	4.0	1.00	2.0	5.0	2.50
M5	0.8	3.70	3.5	4.0	0.5	5.0	1.25	2.5	6.0	3.50
M6	1.00	4.25	4.0	4.0	1.5	6.0	1.50	3.0	6.0	4.00
M8	1.25	6.00	5.5	5.0	2.0	6.0	2.00	4.0	8.0	5.50
M10	1.50	7.40	7.0	6.0	2.5	8.0	2.50	5.0	8.0	7.00
M12	1.75	8.60	8.5	8.0	3.0	10.0	3.00	6.0	12.0	8.50
M16	2.00	12.35	12.0	12.0	4.0	14.0	4.00	8.0	16.0	12.00
M20	2.50	16.00	15.0	14.0	6.0	18.0	5.00	10.0	20.0	15.00
M24	3.00	18.95	18.0	20.0	8.0	20.0	6.00	12.0	22.0	18.00

METRIC LOW HEAD CAP SCREWS

Threads: ANSI B 1.13M, ISO 262
(coarse series only)

Property Class: 10.9

Similar Specifications: DIN 7984,
DIN 6912

NOTES

1. **Material:** ASTM A574M-alloy steel
2. **Hardness:** Rc 33-39
3. **Tensile Stress:** 1040 MPa
4. **Yield Stress:** 940 MPa
5. **Thread Class:** 6g

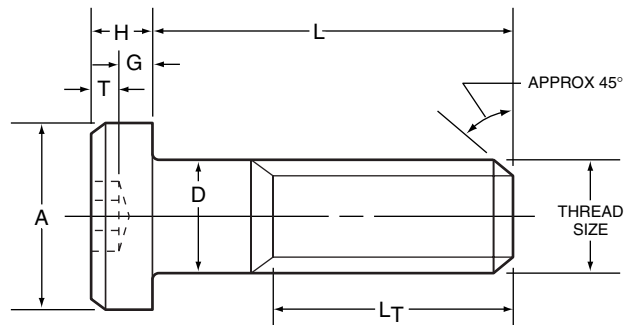
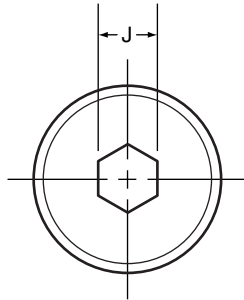
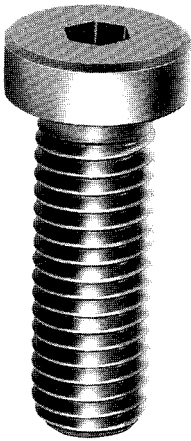

DIMENSIONS

APPLICATION DATA

nom. thread size	pitch	A max.	D max.	G min.	T min.	H max.	L _T min.	J nom.	recommended* seating torque	
									plain	
									N-m	in-lbs.
M4	0.7	7	4	1.06	1.48	2.8	20	3	4.5	40
M5	0.8	8.5	5	1.39	1.85	3.5	22	4	8.5	75
M6	1.0	10	6	1.65	2.09	4.0	24	5	14.5	130
M8	1.25	13	8	2.24	2.48	5.0	28	6	35	310
M10	1.5	16	10	2.86	3.36	6.5	32	8	70	620
M12	1.75	18	12	3.46	4.26	8.0	36	10	120	1060
M16	2.0	24	16	4.91	4.76	10.0	44	12	300	2650
M20	2.5	30	20	6.10	6.07	12.5	52	14	575	5100

All dimensions in millimeters.

*Torque calculated to induce 620 MPa in the screw threads.

Torque values are for plain screws. (See Note, page 1.)

METRIC HEXAGON KEYS

Dimensions ■ Mechanical Properties ■ Socket Applications

These UNBRAKO keys are made to higher requirements than ISO or DIN keys, which may not properly torque Class 12.9 cap screws. The strength and dimensional requirements are necessary to properly install the products in this catalog.

Material: ANSI B18.3.2.M alloy steel

Dimensions: ANSI B18.3.2.M

Similar Specifications: DIN 911, ISO 2936

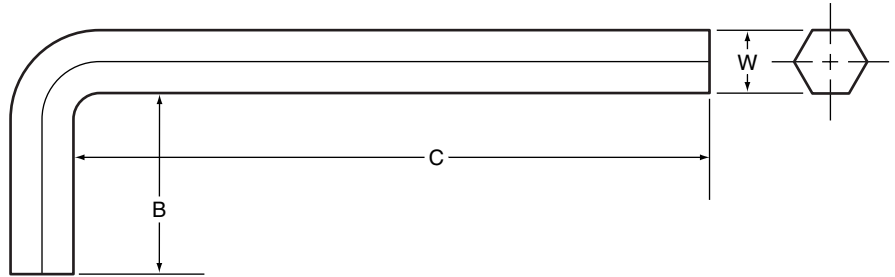

METRIC KEY APPLICATION CHART

size W	socket cap screws		socket cap screws	flat head socket cap screws	button head shoulder screws	socket set screws
	std. head height	low head				
0.7 0.9 1.3						M1.6 M2 M2.5
1.5 2.0 2.5	M1.6/M2 M2.5 M3		M3 M4	M3 M4		M3 M4 M5
3.0 4.0 5.0	M4 M5 M6	M4 M5 M6	M5 M6 M8	M5 M6 M8	M6 M8 M10	M6 M8 M10
6.0 8.0 10.0	M8 M10 M12	M8 M10 M12	M10 M12 M16	M10 M12 M16	M12 M16 M20	M12 M16 M20
12.0 14.0 17.0	M14 M16 M20	M16 M20 M24	M20 M24		M24	M24
19.0 22.0 27.0	M24 M30 M36					
32.0 36.0	M42 M48					

DIMENSIONS

MECHANICAL PROPERTIES

key size W		B nominal	C nominal		torsional shear strength minimum		torsional yield strength minimum	
max.	min.		short arm	long arm	N-m	In-lbs.	N-m	In-lbs.
0.711 0.889 1.270	0.698 0.876 1.244	5.5 9 13.5	31 31 42	*69 71 75	0.12 0.26 0.73	1.1 2.3 6.5	0.1 0.23 .63	0.9 2. 5.6
1.500 2.000 2.500	1.470 1.970 2.470	14 16 18	45 50 56	78 83 90	1.19 2.9 5.4	10.5 26 48	1.02 2.4 4.4	9. 21 39
3.000 4.000 5.000	2.960 3.960 4.960	20 25 28	63 70 80	100 106 118	9.3 22.2 42.7	82 196 378	8. 18.8 36.8	71 166 326
6.000 8.000 10.000	5.960 7.950 9.950	32 36 40	90 100 112	140 160 170	74 183 345	655 1,620 3,050	64 158 296	566 1,400 2,620
12.000 14.000 17.000	11.950 13.930 16.930	45 55 60	125 140 160	212 236 250	634 945 1,690	5,610 8,360 15,000	546 813 1,450	4,830 7,200 12,800
19.000 22.000 24.000	18.930 21.930 23.930	70 80 90	180 *200 *224	280 *335 *375	2,360 3,670 4,140	20,900 32,500 36,600	2,030 3,160 3,560	18,000 28,000 31,500
27.000 32.000 36.000	26.820 31.820 35.820	100 125 140	*250 *315 *355	*500 *630 *710	5,870 8,320 11,800	51,900 73,600 104,000	5,050 7,150 10,200	44,700 63,300 90,300

All dimensions in millimeters.

*Non-stock sizes

ISO TOLERANCES FOR METRIC FASTENERS

nominal dimension		tolerance zone in mm (external measurements)													tolerance zone in mm					
over	to	h6	h8	h10	h11	h13	h14	h15	h16	js14	js15	js16	js17	m6	H7	H8	H9	H11	H13	H14
0	1	0 -0.006	0 -0.014	0 -0.040	0 -0.060	0 -0.14								+0.002 +0.008	+0.010 0	+0.0014 0	+0.025 0	+0.060 0	+0.14 0	
1	3	0 -0.006	0 -0.014	0 -0.040	0 -0.060	0 -0.14	0 -0.25	0 -0.40	0 -0.60	±0.125	±0.20	±0.30	±0.50	+0.002 +0.008	+0.010 0	+0.014 0	+0.025 0	+0.060 0	+0.14 0	+0.25 0
3	6	0 -0.008	0 -0.018	0 -0.048	0 -0.075	0 -0.18	0 -0.30	0 -0.48	0 -0.75	±0.15	±0.24	±0.375	±0.60	+0.004 +0.012	+0.012 0	+0.018 0	+0.030 0	+0.075 0	+0.18 0	+0.30 0
6	10	0 -0.009	0 -0.022	0 -0.058	0 -0.090	0 -0.22	0 -0.36	0 -0.58	0 -0.90	±0.18	±0.29	±0.45	±0.75	+0.006 +0.0015	+0.015 0	+0.022 0	+0.036 0	+0.090 0	+0.22 0	+0.36 0
10	18	0 -0.011	0 -0.027	0 -0.070	0 -0.110	0 -0.27	0 -0.43	0 -0.70	0 -1.10	±0.215	±0.35	±0.55	±0.90	+0.007 +0.018	+0.018 0	+0.027 0	+0.043 0	+0.110 0	+0.27 0	+0.43 0
18	30	0 -0.030	0 -0.033	0 -0.084	0 -0.130	0 -0.33	0 -0.52	0 -0.84	0 -1.30	±0.26	±0.42	±0.65	±1.05	+0.008 +0.021	+0.021 0	+0.033 0	+0.052 0	+0.130 0	+0.33 0	+0.52 0
30	50					0 -0.39	0 -0.62	0 -1.00	0 -1.60	±0.31	±0.50	±0.80	±1.25						+0.39 0	+0.62 0
50	80					0 -0.46	0 -0.74	0 -1.20	0 -1.90	±0.37	±0.60	±0.95	±1.50						+0.46 0	+0.74 0
80	120					0 -0.54	0 -0.87	0 -1.40	0 -2.20	±0.435	±0.70	±1.10	±1.75						+0.54 0	+0.87 0
120	180									±0.50	±0.80	±1.25	±2.00							
180	250									±0.575	±0.925	±1.45	±2.30							
250	315									±0.65	±1.05	±1.60	±2.60							
315	400									±0.70	±1.15	±1.80	±2.85							
400	500									±0.775	±1.25	±2.00	±3.15							

ISO TOLERANCES FOR SOCKET SCREWS

nominal dimension		tolerance zone in mm										
over	to	C13	C14	D9	D10	D11	D12	EF8	E11	E12	Js9	K9
	3	+0.20 +0.06	+0.31 +0.06	+0.045 +0.020	+0.060 +0.020	+0.080 +0.020	+0.12 +0.02	+0.024 +0.010	+0.074 +0.014	+0.100 +0.014	±0.0125	0 -0.025
3	6	+0.24 +0.06	+0.37 +0.07	+0.060 +0.030	+0.078 +0.030	+0.115 +0.030	+0.15 +0.03	+0.028 +0.014	+0.095 +0.020	+0.140 +0.020	±0.015	0 -0.030
6	10					+0.130 +0.040	+0.19 +0.40	+0.040 +0.018	+0.115 +0.025	+0.115 +0.025	±0.018	0 -0.036
10	18						+0.2 +0.05		+0.142 +0.032	+0.212 +0.032		
18	30						+0.275 +0.065					
30	50						+0.33 +0.08					
50	80						+0.40 +0.10					

References

ISO R 286
ISO 4759/I
ISO 4759/II
ISO 4759/III

Notes

ANSI standards allow slightly wider tolerances for screw lengths than ISO and DIN.



The table is intended to assist in the design with metric fasteners. For tolerances not listed here refer to the complete standards.

ISO TOLERANCES

Tolerances for Metric Fasteners

The tolerances in the tables below are derived from ISO standard: ISO 4759

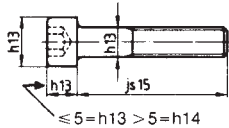
The tables show tolerances on the most common metric fasteners. However, occasionally some slight modifications are made.

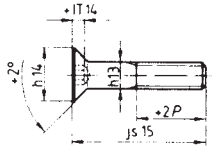
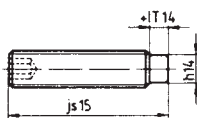
Item	DIN	Item	DIN
	912		913 914 916
	7991		915 966

Notes

Product grade A applies to sizes up to M24 and length not exceeding 10 x diameter or 150 mm, whatever is shorter.

Product grade B applies to the sizes above M24 and all sizes with lengths, greater than 10 x diameter or 150 mm, whichever is shorter.

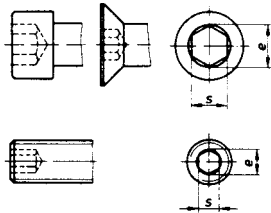
Feature	Tolerance	
	s	* **
Hexagon Sockets 	0.7	EF8
	0.9	JS9
	1.3	K9
	1.5	D9 D10
	2	
	2.5	D10 D11
	3	D11
	4	E11 E12
	5	
	6	
	8	
	10	
	12	D12
	14	
	>14	D12

*Tolerance zones for socket set screws

**Tolerance zones for socket head cap screws

Note: For S 0.7 to 1.3 the actual allowance in the product standards has been slightly modified for technical reasons.

CONVERSION CHART

SI UNITS & CONVERSIONS FOR CHARACTERISTICS OF MECHANICAL FASTENERS						
property	unit	symbol	conversion			approximate equivalent
			from	to	multiply by	
length	meter centimeter millimeter	m cm mm	inch inch foot	mm cm mm	25.4 2.54 304.8	25mm = 1 in. 300mm = 1ft. 1m = 39.37 in.
mass	kilogram gram tonne (megagram)	kg g t	ounce pound ton (2000 lb)	g kg kg	28.35 .4536 907.2	28g = 1 oz. 1kg = 2.2 lb. = 35 oz. 1t = 2200 lbs.
density	kilogram per cubic meter	kg/m ³	pounds per cu. ft.	kg/m	16.02	16kg/m = 1 lb/ft. ³
temperature	deg. Celsius	°C	deg. Fahr.	°C	(°F - 32) x 5/9	0°C = 32°F 100°C = 212°F
area	square meter square millimeter	m ² mm ²	sq. in. sq. ft.	mm ² m ²	645.2 .0929	645mm ² = 1 in. ² 1m ² = 11 ft. ²
volume	cubic meter cubic centimeter cubic millimeter	m ³ cm ³ mm ³	cu. in. cu.ft. cu. yd.	mm ³ m ³ m ³	16387 .02832 .7645	16400mm ³ = 1 in. ³ 1m ³ = 35 ft. ³ 1m ³ = 1.3 yd. ³
force	newton kilonewton meganewton	N kN MN	ounce (Force) pound (Force) Kip	N kN MN	.278 .00445 .00445	1N = 3.6 ozf 4.4N = 1 lbf 1kN = 225 lbf
stress	megapascal newtons/sq.m	MPa N/m ²	pound/in ² (psi) Kip/in ² (ksi)	MPa MPa	.0069 6.895	1MPa = 145 psi 7MPa = 1 ksi
torque	newton-meter	N•m	inch-ounce inch-pound foot-pound	N-m N-m N-m	.00706 .113 1.356	1N•m = 140 in. oz. 1N•m = 9 in. lb. 1N•m = .75 ft. lb. 1.4 N•m = 1 ft. lb.

TABLE OF CONTENTS

Technical Section

	Page
Screw Fastener Theory and Application	52
Joint Diagrams	56
The Torque-Tension Relationship	62
Stripping Strength of Tapped Holes	64
High-Temperature Joints	68
Corrosion In Threaded Fasteners	71
Impact Performance	75
Product Engineering Bulletin	79
Metric Threads	80
Through-Hole Preparation	82
Drill and Counterbore Sizes	83
Hardness-Tensile Conversion Chart	84
Thread Stress Area	85
Optional Part Numbering System	86 thru 89

IMPORTANT

The technical discussions represent typical applications only. The use of the information is at the sole discretion of the reader. Because applications vary enormously, UNBRAKO does not warrant the scenarios described are appropriate for any specific application. The reader must consider all variables prior to using this information.

INSTALLATION CONTROL

Several factors should be considered in designing a joint or selecting a fastener for a particular application.

JOINT DESIGN AND FASTENER SELECTION.

Joint Length

The longer the joint length, the greater the total elongation will occur in the bolt to produce the desired clamp load or preload. In design, if the joint length is increased, the potential loss of preload is decreased.

Joint Material

If the joint material is relatively stiff compared to the bolt material, it will compress less and therefore provide a less sensitive joint, less sensitive to loss of preload as a result of brinelling, relaxation and even loosening.

Thread Stripping Strength

Considering the material in which the threads will be tapped or the nut used, there must be sufficient engagement length to carry the load. Ideally, the length of thread engagement should be sufficient to break the fastener in tension. When a nut is used, the wall thickness of the nut as well as its length must be considered.

An estimate, a calculation or joint evaluation will be required to determine the tension loads to which the bolt and joint will be exposed. The size bolt and the number necessary to carry the load expected, along with the safety factor, must also be selected.

The safety factor selected will have to take into consideration the consequence of failure as well as the additional holes and fasteners. Safety factors, therefore, have to be determined by the designer.

SHEAR APPLICATIONS

Shear Strength of Material

Not all applications apply a tensile load to the fastener. In many cases, the load is perpendicular to the fastener in shear. Shear loading may be single, double or multiple loading.

There is a relationship between the tensile strength of a material and its shear strength. For alloy steel, the shear strength is 60% of its tensile strength. Corrosion resistant steels (e.g. 300-Series stainless steels) have a lower tensile/shear relationship and it is usually 50-55%

Single/Double Shear

Single shear strength is exactly one-half the double shear value. Shear strength listed in pounds per square inch (psi) is the shear load in pounds multiplied by the cross sectional area in square inches.

Single Shear

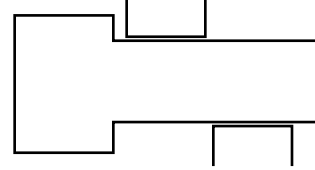

Double Shear

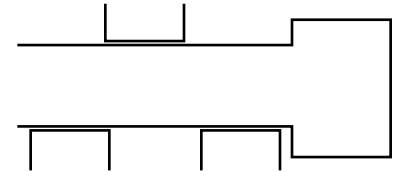

OTHER DESIGN CONSIDERATIONS

Application Temperature

For elevated temperature, standard alloy steels are useful to about 550°F–600°F. However, if plating is used, the maximum temperature may be less (eg. cadmium should not be used over 450°F).

Austenitic stainless steels (300 Series) may be useful to 800°F. They can maintain strength above 800°F but will begin to oxidize on the surface.

Corrosion Environment

A plating may be selected for mild atmospheres or salts. If plating is unsatisfactory, a corrosion resistant fastener may be specified. The proper selection will be based upon the severity of the corrosive environment.

FATIGUE STRENGTH

S/N Curve

Most comparative fatigue testing and specification fatigue test requirements are plotted on an S/N curve. In this curve, the test stress is shown on the ordinate (y-axis) and the number of cycles is shown on the abscissa (x-axis) in a logarithmic scale. On this type curve, the high load to low load ratio must be shown. This is usually $R = .1$, which means the low load in all tests will be 10% of the high load.

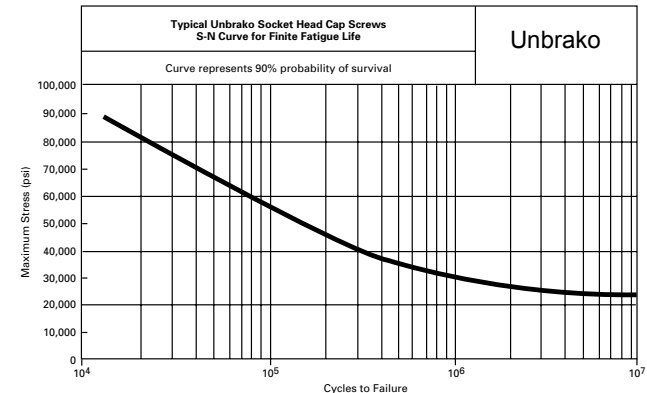

Effect of Preload

Increasing the R to .2, .3 or higher will change the curve shape. At some point in this curve, the number of cycles will reach 10 million cycles. This is considered the

SCREW FASTENER THEORY & APPLICATIONS

endurance limit or the stress at which infinite life might be expected.

Modified Goodman/ Haigh Soderberg Curve

The S/N curve and the information it supplies will not provide the information needed to determine how an individual fastener will perform in an actual application. In application, the preload should be higher than any of the preloads on the S/N curve.

Therefore, for application information, the modified Goodman Diagram and/or the Haigh Soderberg Curve are more useful. These curves will show what fatigue performance can be expected when the parts are properly preloaded.

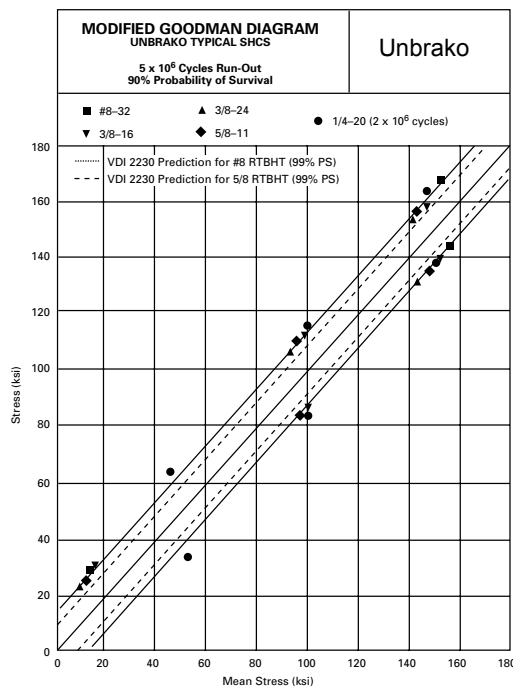

METHODS OF PRELOADING

Elongation

The modulus for steel of 30,000,000 (thirty million) psi means that a fastener will elongate .001 in/in of length for every 30,000 psi in applied stress. Therefore, if 90,000 psi is the desired preload, the bolt must be stretched .003 inches for every inch of length in the joint.

This method of preloading is very accurate but it requires that the ends of the bolts be properly prepared and also that all measurements be very carefully made. In addition, direct measurements are only possible where both ends of the fastener are available for measurement after installation. Other methods of measuring length changes are ultrasonic, strain gages and turn of the nut.

Torque

By far, the most popular method of preloading is by torque. Fastener manufacturers usually have recommended seating torques for each size and material fastener. The only requirement is the proper size torque wrench, a conscientious operator and the proper torque requirement.

Strain

Since stress/strain is a constant relationship for any given material, we can use that relationship just as the elongation change measurements were used previously.

Now, however, the strain can be detected from strain gages applied directly to the outside surface of the bolt or by having a hole drilled in the center of the bolt and the strain gage installed internally. The output from these gages need instrumentation to convert the gage electrical measurement method. It is, however, an expensive method and not always practical.

Turn of the Nut

The nut turn method also utilizes change in bolt length. In theory, one bolt revolution (360° rotation) should increase the bolt length by the thread pitch. There are at least two variables, however, which influence this relationship. First, until a snug joint is obtained, no bolt elongation can be measured. The snugging produces a large variation in preload. Second, joint compression is also taking place so the relative stiffnesses of the joint and bolt influences the load obtained.

VARIABLES IN TORQUE

Coefficient of Friction

Since the torque applied to a fastener must overcome all friction before any loading takes place, the amount of friction present is important.

In a standard unlubricated assembly, the friction to be overcome is the head bearing area and the thread-to-thread friction. Approximately 50% of the torque applied will be used to overcome this head-bearing friction and approximately 35% to overcome the thread friction. So 85% of the torque is overcoming friction and only 15% is available to produce bolt load.

If these interfaces are lubricated (cadmium plate, molybdenum disulfide, anti-seize compounds, etc.), the friction is reduced and thus greater preload is produced with the same torque.

The change in the coefficient of friction for different conditions can have a very significant effect on the slope of the torque tension curve. If this is not taken into consideration, the proper torque specified for a plain unlubricated bolt may be sufficient to yield or break a lubricated fastener.

Thread Pitch

The thread pitch must be considered when a given stress is to be applied, since the cross-sectional area used for stress calculations is the thread tensile stress area and is different for coarse and fine threads. The torque recommendations, therefore, are slightly higher for fine threads than for coarse threads to achieve the same stress.

Differences between coarse and fine threads.

Coarse Threads are...

- more readily available in industrial fasteners.
- easier to assemble because of larger helix angle.
- require fewer turns and reduce cross threading.
- higher thread stripping strength per given length.
- less critical of tap drill size.
- not as easily damaged in handling.

Their disadvantages are...

- lower tensile strength.
- reduced vibrational resistance.
- coarse adjustment.

Fine Threads provide...

- higher tensile strength.
- greater vibrational resistance.
- finer adjustment.

Their disadvantages are...

- easier cross threaded.
- threads damaged more easily by handling.
- tap drill size slightly more critical.
- slightly lower thread stripping strength.

Other Design Guidelines

In addition to the joint design factors discussed, the following considerations are important to the proper use of high-strength fasteners.

- Adequate thread engagement should be guaranteed by use of the proper mating nut height for the system. Minimum length of engagement recommended in a tapped hole depends on the strength of the material, but in all cases should be adequate to prevent stripping.
- Specify nut of proper strength level. The bolt and nut should be selected as a system.
- Specify compatible mating female threads. 2B tapped holes or 3B nuts are possibilities.
- Corrosion, in general, is a problem of the joint, and not just of the bolt alone. This can be a matter of galvanic action between dissimilar metals. Corrosion of the fastener material surrounding the bolt head or nut can be critical with high-strength bolting. Care must be exercised in the compatibility of joint materials and/or coatings to protect dissimilar metals.

PROCESSING CONTROL

The quality of the raw material and the processing control will largely affect the mechanical properties of the finished parts.

MATERIAL SELECTION

The selection of the type of material will depend on its end use. However, the control of the analysis and quality is a critical factor in fastener performance. The material must yield reliable parts with few hidden defects such as cracks, seams, decarburization and internal flaws.

FABRICATION METHOD

Head

There are two general methods of making bolt heads, forging and machining. The economy and grain flow resulting from forging make it the preferred method.

The temperature of forging can vary from room temperature to 2000°F. By far, the greatest number of parts are cold upset on forging machines known as headers or boltmakers. For materials that do not have enough formability for cold forging, hot forging is used. Hot forging is also used for bolts too large for cold upsetting due to machine capacity. The largest cold forging

machines can make bolts up to 1-1/2 inch diameter. For large quantities of bolts, hot forging is more expensive than cold forging.

Some materials, such as stainless steel, are warm forged at temperatures up to 1000°F. The heating results in two benefits, lower forging pressures due to lower yield strength and reduced work hardening rates.

Machining is the oldest method and is used for very large diameters or small production runs.

The disadvantage is that machining cuts the metal grain flow, thus creating planes of weakness at the critical head-to-shank fillet area. This can reduce tension fatigue performance by providing fracture planes.

Fillet

The head-to-shank transition (fillet) represents a sizable change in cross section at a critical area of bolt performance. It is important that this notch effect be minimized. A generous radius in the fillet reduces the notch effect. However, a compromise is necessary because too large a radius will reduce load-bearing area under the head.

Composite radii such as elliptical fillets, maximize curvature on the shank side of the fillet and minimize it on the head side to reduce loss of bearing area on the load-bearing surface.

Critical Fastener Features

Head-Shank-Fillet: This area on the bolt must not be restricted or bound by the joint hole. A sufficient chamfer or radius on the edge of the hole will prevent interference that could seriously reduce fatigue life. Also, if the bolt should seat on an unchamfered edge, there might be serious loss of preload if the edge breaks under load.

Threads

Threads can be produced by grinding, cutting or rolling.

In a rolled thread, the material is caused to flow into the thread die contour, which is ground into the surface during the manufacture of the die. Machines with two or three circular dies or two flat dies are most common.

Thread cutting requires the least tooling costs and is by far the most popular for producing internal threads. It is the most practical method for producing thin wall parts and the only technique available for producing large diameter parts (over 3 inches in diameter).

Thread grinding yields high dimensional precision and affords good control of form and finish. It is the only practical method for producing thread plug gages.

Both machining and grinding have the disadvantage of cutting material fibers at the most critical point of performance.

The shape or contour of the thread has a great effect on the resulting fatigue life. The thread root should be large and well rounded without sharp corners or stress risers. Threads with larger roots should always be used for harder materials.

In addition to the benefits of grain flow and controlled shape in thread rolling, added fatigue life can result when the rolling is performed after heat treatment.

SCREW FASTENER THEORY & APPLICATIONS

This is the accepted practice for high fatigue performance bolts such as those used in aircraft and space applications.

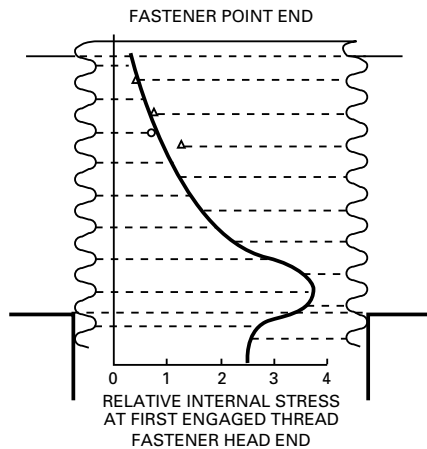

EVALUATING PERFORMANCE

Mechanical Testing

In the fastener industry, a system of tests and examinations has evolved which yields reliable parts with proven performance.

Some tests are conducted on the raw material; some on the finished product.

There always seems to be some confusion regarding mechanical versus metallurgical properties. Mechanical properties are those associated with elastic or inelastic reaction when force is applied, or that involve the relationship between stress and strain. Tensile testing stresses the fastener in the axial direction. The force at which the fastener breaks is called the breaking load or ultimate tensile strength. Load is designated in pounds, stress in pounds per square inch and strain in inches per inch.

When a smooth tensile specimen is tested, the chart obtained is called a Stress-Strain Curve. From this curve, we can obtain other useful data such as yield strength. The method of determining yield is known as the offset method and consists of drawing a straight line parallel to the stress strain curve but offset from the zero point by a specified amount. This value is usually 0.2% on the strain ordinate. The yield point is the intersection of the stress-strain curve and the straight line. This method is not applicable to fasteners because of the variables introduced by their geometry.

When a fastener tensile test is plotted, a load/elongation curve can be obtained. From this curve, a yield determination known as Johnson's 2/3 approximate method for determination of yield strength is used to establish fastener yield, which will be acceptable for design purposes. It is not recommended for quality control or specification requirements.

Torque-tension testing is conducted to correlate the required torque necessary to induce a given load in a mechanically fastened joint. It can be performed by hand or machine. The load may be measured by a tensile machine, a load cell, a hydraulic tensile indicator or by a strain gage.

Fatigue tests on threaded fasteners are usually alternating tension-tension loading. Most testing is done at more severe strain than its designed service load but usually below the material yield strength.

Shear testing, as previously mentioned, consists of loading a fastener perpendicular to its axis. All shear testing should be accomplished on the unthreaded portion of the fastener.

Checking hardness of parts is an indirect method for testing tensile strength. Over the years, a correlation of tensile strength to hardness has been obtained for most materials. See page 83 for more detailed information. Since hardness is a relatively easy and inexpensive test, it makes a good inspection check. In hardness checking, it is very important that the specimen be properly prepared and the proper test applied.

Stress durability is used to test parts which have been subjected to any processing which may have an embrittling effect. It requires loading the parts to a value higher than the expected service load and maintaining that load for a specified time after which the load is removed and the fastener examined for the presence of cracks.

Impact testing has been useful in determining the ductile brittle transformation point for many materials. However, because the impact loading direction is transverse to a fastener's normal longitudinal loading, its usefulness for fastener testing is minimal. It has been shown that many fastener tension impact strengths do not follow the same pattern or relationship of Charpy or Izod impact strength.

Metallurgical Testing

Metallurgical testing includes chemical composition, microstructure, grain size, carburization and decarburization, and heat treat response.

The chemical composition is established when the material is melted. Nothing subsequent to that process will influence the basic composition.

The microstructure and grain size can be influenced by heat treatment. Carburization is the addition of carbon to the surface which increases hardness. It can occur if heat treat furnace atmospheres are not adequately controlled. Decarburization is the loss of carbon from the surface, making it softer. Partial decarburization is preferable to carburization, and most industrial standards allow it within limits.

In summary, in order to prevent service failures, many things must be considered:

The Application Requirements

- Strength Needed – Safety Factors
- Tension/Shear/Fatigue
- Temperature
- Corrosion
- Proper Preload

The Fastener Requirements

- Material
- Fabrication Controls
- Performance Evaluations

AN EXPLANATION OF JOINT DIAGRAMMS

When bolted joints are subjected to external tensile loads, what forces and elastic deformation really exist? The majority of engineers in both the fastener manufacturing and user industries still are uncertain. Several papers, articles, and books, reflecting various stages of research into the problem have been published and the volume of this material is one reason for confusion. The purpose of this article is to clarify the various explanations that have been offered and to state the fundamental concepts which apply to forces and elastic deformations in concentrically loaded joints. The article concludes with general design formulae that take into account variations in tightening, preload loss during service, and the relation between preloads, external loads and bolt loads.

The Joint Diagram

Forces less than proof load cause elastic strains. Conversely, changes in elastic strains produce force variations. For bolted joints this concept is usually demonstrated by joint diagrams.

The most important deformations within a joint are elastic bolt elongation and elastic joint compression in the axial direction. If the bolted joint in Fig. 1 is subjected to the preload F_i the bolt elongates as shown by the line OB in Fig. 2A and the joint compresses as shown by the line OJ. These two lines, representing the spring characteristics of the bolt and joint, are combined into one diagram in Fig. 2B to show total elastic deformation.

If a concentric external load F_e is applied under the bolt head and nut in Fig. 1, the bolt elongates an additional amount while the compressed joint members partially relax. These changes in deformation with external loading are the key to the interaction of forces in bolted joints.

In Fig. 3A the external load F_e is added to the joint diagram F_e is located on the diagram by applying the upper end to an extension of OB and moving it in until the lower end contacts OJ. Since the total amount of elastic deformation (bolt plus joint) remains constant for a given preload, the external load changes the total bolt elongation to $\Delta l_b + \lambda$ and the total joint compression to $\Delta l_j - \lambda$.

In Fig. 3B the external load F_e is divided into an additional bolt load F_{eB} and the joint load F_{eJ} , which unloads the compressed joint members. The maximum bolt load is the sum of the load preload and the additional bolt load:

$$F_{B \max} = F_i + F_{eB}$$

If the external load F_e is an alternating load, F_{eB} is that part of F_e working as an alternating bolt load, as shown in Fig. 3B. This joint diagram also illustrates that the joint absorbs more of the external load than the bolt subjected to an alternating external load.

The importance of adequate preload is shown in Fig. 3C. Comparing Fig. 3B and Fig. 3C, it can be seen that F_{eB} will remain relatively small as long as the preload F_i is greater than F_{eJ} . Fig. 3C represents a joint with insufficient preload. Under this condition, the amount of external load that the joint can absorb is limited, and the excess

load must then be applied to the bolt. If the external load is alternating, the increased stress levels on the bolt produce a greatly shortened fatigue life.

When seating requires a certain minimum force or when transverse loads are to be transformed by friction, the minimum clamping load $F_{J \min}$ is important.

$$F_{J \min} = F_{B \max} - F_e$$

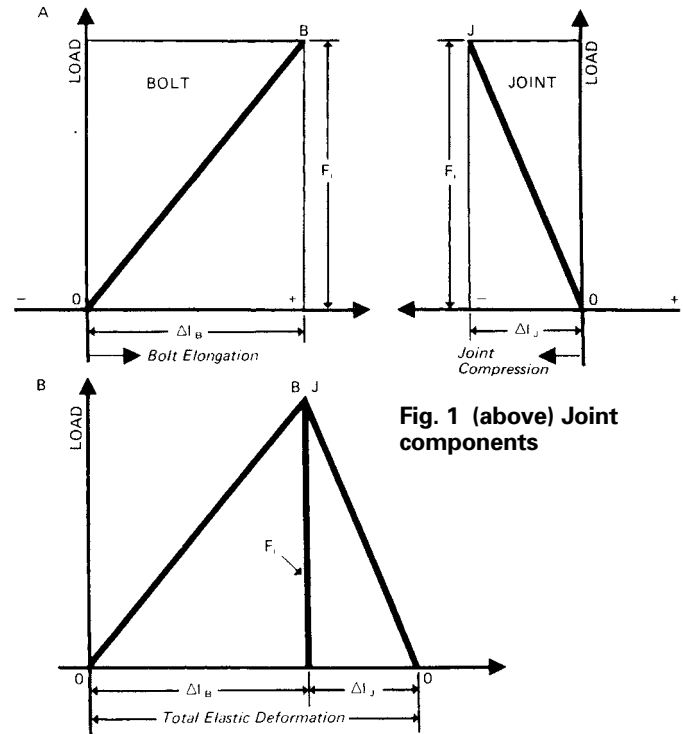

Fig. 1 (above) Joint components

Fig. 2 Joint diagram is obtained by combining load vs. deformation diagrams of bolt and joints.

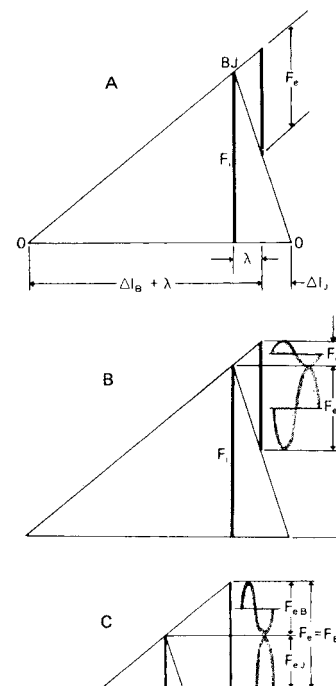

Fig. 3 The complete simple joint diagrams show external load F_e added (A), and external load divided into an additional bolt load F_{eB} and reduction in joint compression F_{eJ} (B). Joint diagram (C) shows how insufficient preload F_i causes excessive additional bolt load F_{eB} .

Spring Constants

To construct a joint diagram, it is necessary to determine the spring rates of both bolt and joint. In general, spring rate is defined as:

$$K = \frac{F}{\Delta l}$$

From Hook's law:

$$\Delta l = \frac{F l}{EA}$$

Therefore:

$$K = \frac{EA}{l}$$

To calculate the spring rate of bolts with different cross sections, the reciprocal spring rates, or compliances, of each section are added:

$$\frac{1}{K_B} = \frac{1}{K_1} + \frac{1}{K_2} + \dots + \frac{1}{K_n}$$

Thus, for the bolt shown in Fig. 4:

$$\frac{1}{K_B} = \frac{1}{E} \left(\frac{0.4d}{A_1} + \frac{l_1}{A_1} + \frac{l_2}{A_2} + \frac{l_3}{A_m} + \frac{0.4d}{A_m} \right)$$

where

d = the minor thread diameter and

A_m = the area of the minor thread diameter

This formula considers the elastic deformation of the head and the engaged thread with a length of $0.4d$ each.

Calculation of the spring rate of the compressed joint members is more difficult because it is not always obvious which parts of the joint are deformed and which are not. In general, the spring rate of a clamped part is:

$$K_J = \frac{EA_s}{l_J}$$

where A_s is the area of a substitute cylinder to be determined.

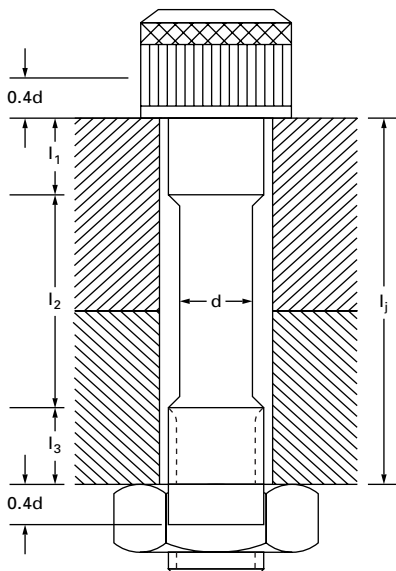

Fig. 4 Analysis of bolt lengths contributing to the bolt spring rate.

When the outside diameter of the joint is smaller than or equal to the bolt head diameter, i.e., as in a thin bushing, the normal cross sectioned area is computed:

$$A_s = \frac{\pi}{4} (D_c^2 - D_h^2)$$

where

D_c = OD of cylinder or bushing and

D_h = hole diameter

When the outside diameter of the joint is larger than head or washer diameter D_H , the stress distribution is in the shape of a barrel, Fig 5. A series of investigations proved that the areas of the following substitute cylinders are close approximations for calculating the spring contents of concentrically loaded joints.

When the joint diameter D_J is greater than D_H but less than $3D_H$:

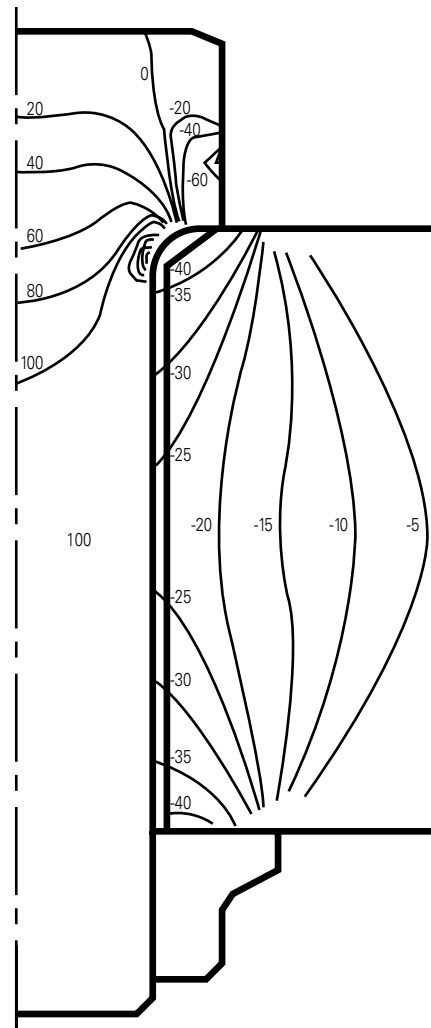

Fig. 5 Lines of equal axial stresses in a bolted joint obtained by the axisymmetric finite element method are shown for a 9/16-18 bolt preloaded to 100 KSI; positive numbers are tensile stresses in KSI; negative numbers are compressive stresses in KSI.

$$A_s = \frac{\pi}{4} (D_H^2 - D_n^2) + \frac{\pi}{8} \left(\frac{D_J}{D_H} - 1 \right) \left(\frac{D_H l_J}{5} + \frac{l_J^2}{100} \right)$$

When the joint diameter D_J is equal to or greater than $3D_H$:

$$A_s = \frac{\pi}{4} [(D_H + 0.1 l_J)^2 - D_n^2]$$

These formulae have been verified in laboratories by finite element method and by experiments.

Fig. 6 shows joint diagrams for springy bolt and stiff joint and for a stiff bolt and springy joint. These diagrams demonstrate the desirability of designing with springy bolt and a stiff joint to obtain a low additional bolt load F_{eB} and thus a low alternating stress.

The Force Ratio

Due to the geometry of the joint diagram, Fig. 7,

$$F_{eB} = \frac{F_e K_B}{K_B + K_J}$$

Defining $\Phi = \frac{K_B}{K_B + K_J}$

$F_{eB} = F_e \Phi$ and Φ , called the Force Ratio, $= \frac{F_{eB}}{F_e}$

For complete derivation of Φ , see Fig. 7.

To assure adequate fatigue strength of the selected fastener the fatigue stress amplitude of the bolt resulting from an external load F_e is computed as follows:

$$\sigma_B = \pm \frac{F_{eB}/2}{A_m} \quad \text{or}$$

$$\sigma_B = \pm \frac{\Phi F_e}{2 A_m}$$

Effect of Loading Planes

The joint diagram in Fig 3, 6 and 7 is applicable only when the external load F_e is applied at the same loading planes as the preloaded F_i , under the bolt head and the nut. However, this is a rare case, because the external load usually affects the joint somewhere between the center of the joint and the head and the nut.

When a preloaded joint is subjected to an external load F_e at loading planes 2 and 3 in Fig. 8, F_e relieves the compression load of the joint parts between planes 2 and 3. The remainder of the system, the bolt and the joint parts between planes 1-2 and 3-4, feel additional load due to F_e applied planes 2 and 3, the joint material between planes 2 and 3 is the clamped part and all other joint members, fastener and remaining joint material, are clamping parts. Because of the location of the loading planes, the joint diagram changes from black line to the blue line. Consequently, both the additional bolt load F_{Bmax} decrease significantly when the loading planes of F_e shift from under the bolt head and nut toward the joint center.

Determination of the length of the clamped parts is, however, not that simple. First, it is assumed that the external load is applied at a plane perpendicular to the bolt axis. Second, the distance of the loading planes from each other has to be estimated. This distance may be expressed as the ratio of the length of clamped parts to the total joint length. Fig. 9 shows the effect of two different loading planes on the bolt load, both joints having the same preload F_i and the same external load F_e . The lengths of the clamped parts are estimated to be $0.75l_J$ for joint A, and $0.25l_J$ for joint B.

In general, the external bolt load is somewhere between $F_{eB} = 1\Phi F_e$ for loading planes under head and nut and $F_{eB} = 0\Phi F_e = 0$ when loading planes are in the joint center, as shown in Fig. 10. To consider the loading planes in calculations, the formula:

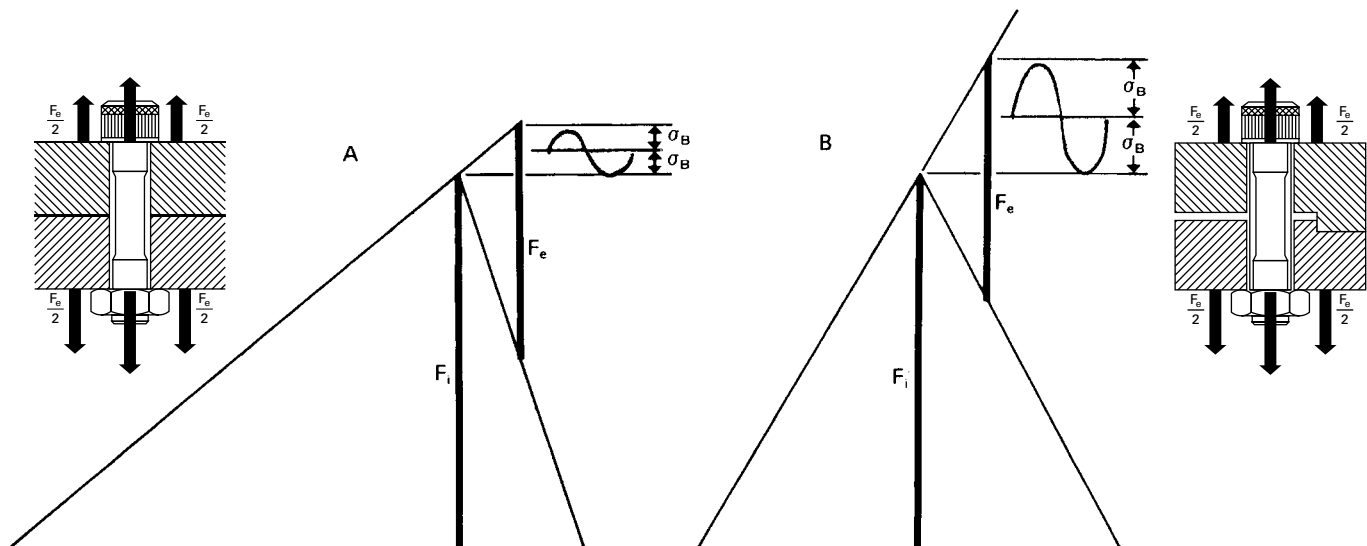

Fig. 6 Joint diagram of a springy bolt in a stiff joint (A), is compared to a diagram of a stiff bolt in a springy joint (B). Preload F_i and external load F_e are the same but diagrams show that alternating bolt stresses are significantly lower with a spring bolt in a stiff joint.

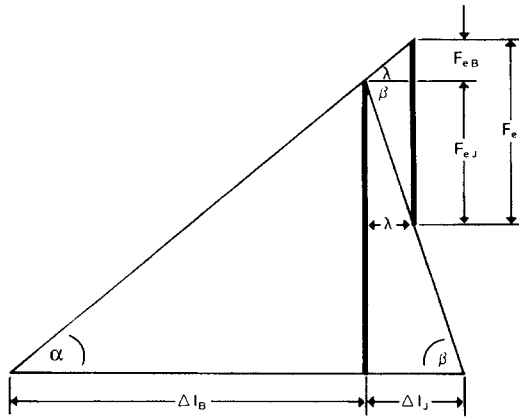

Fig. 7 Analysis of external load F_e and derivation of Force Ratio Φ .

$$\tan \alpha = \frac{F_i}{\Delta l_B} = K_B \text{ and } \tan \beta = \frac{F_j}{\Delta l_j} = K_j$$

$$\lambda = \frac{F_{eB}}{\tan \alpha} = \frac{F_{eJ}}{\tan \beta} = \frac{F_e B}{K_B} = \frac{F_{eJ}}{K_j} \text{ or}$$

$$F_{eJ} = \lambda \tan \beta \text{ and } F_{eB} = \lambda \tan \alpha$$

$$\text{Since } F_e = F_{eB} + F_{eJ}$$

$$F_e = F_{eB} + \lambda \tan \beta$$

Substituting $\frac{F_{eB}}{\tan \alpha}$ for λ produces:

$$F_e = F_{eB} + \frac{F_{eB} \tan \beta}{\tan \alpha}$$

Multiplying both sides by $\tan \alpha$:

$$F_e \tan \alpha = F_{eB} (\tan \alpha + \tan \beta) \text{ and}$$

$$F_{eB} = \frac{F_e \tan \alpha}{\tan \alpha + \tan \beta}$$

Substituting K_B for $\tan \alpha$ and K_j for $\tan \beta$

$$F_{eB} = F_e \frac{K_B}{K_B + K_j}$$

$$\text{Defining } \Phi = \frac{K_B}{K_B + K_j}$$

$$F_{eB} = \Phi F_e$$

$$\Phi = \frac{F_{eB}}{F_e} \text{ and it becomes obvious why } \Phi \text{ is called force ratio.}$$

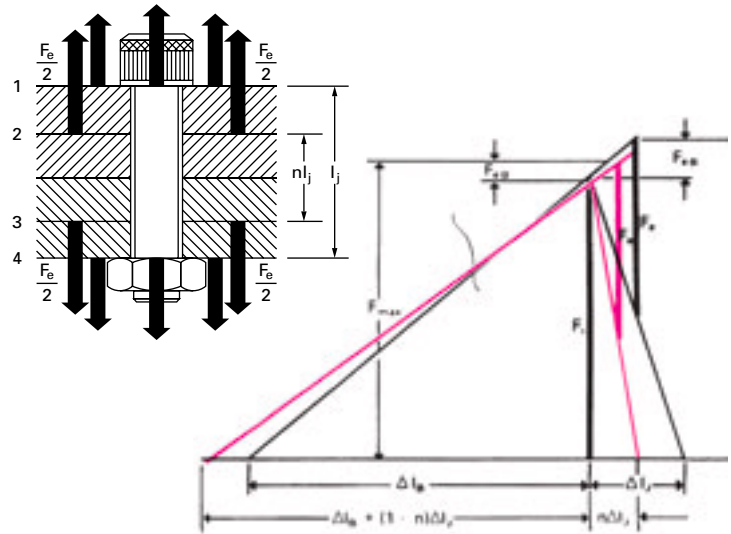

Fig. 8 Joint diagram shows effect of loading planes of F_e on bolt loads F_{eB} and $F_{B \max}$. Black diagram shows F_{eB} and $F_{B \max}$ resulting from F_e applied in planes 1 and 4. Orange diagram shows reduced bolt loads when F_e is applied in planes 2 and 3.

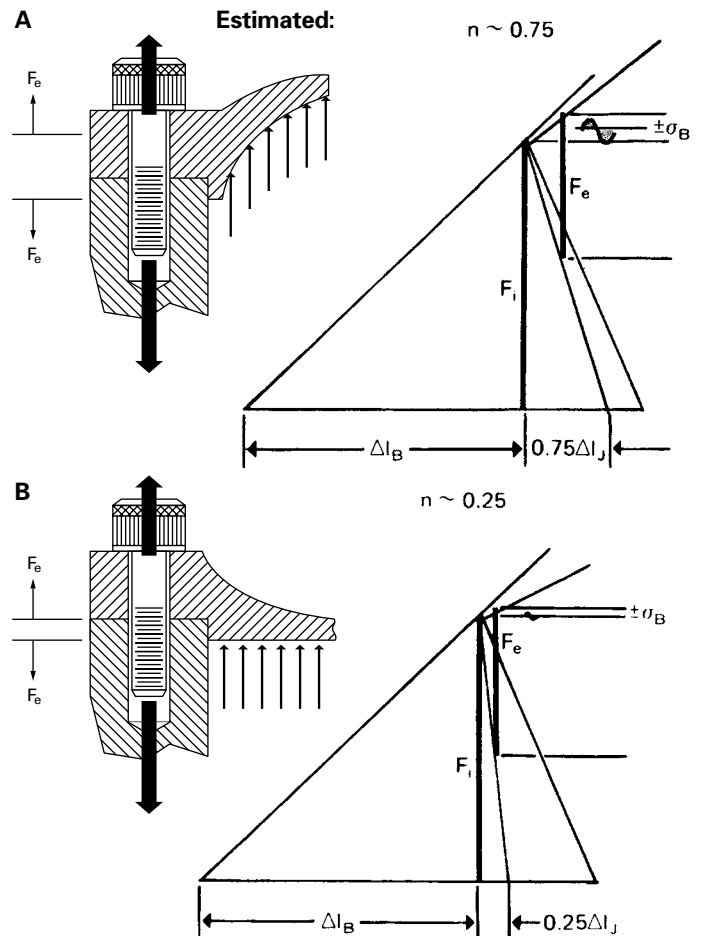

Fig. 9 When external load is applied relatively near bolt head, joint diagram shows resulting alternating stress α_B (A). When same value external load is applied relatively near joint center, lower alternating stress results (B).

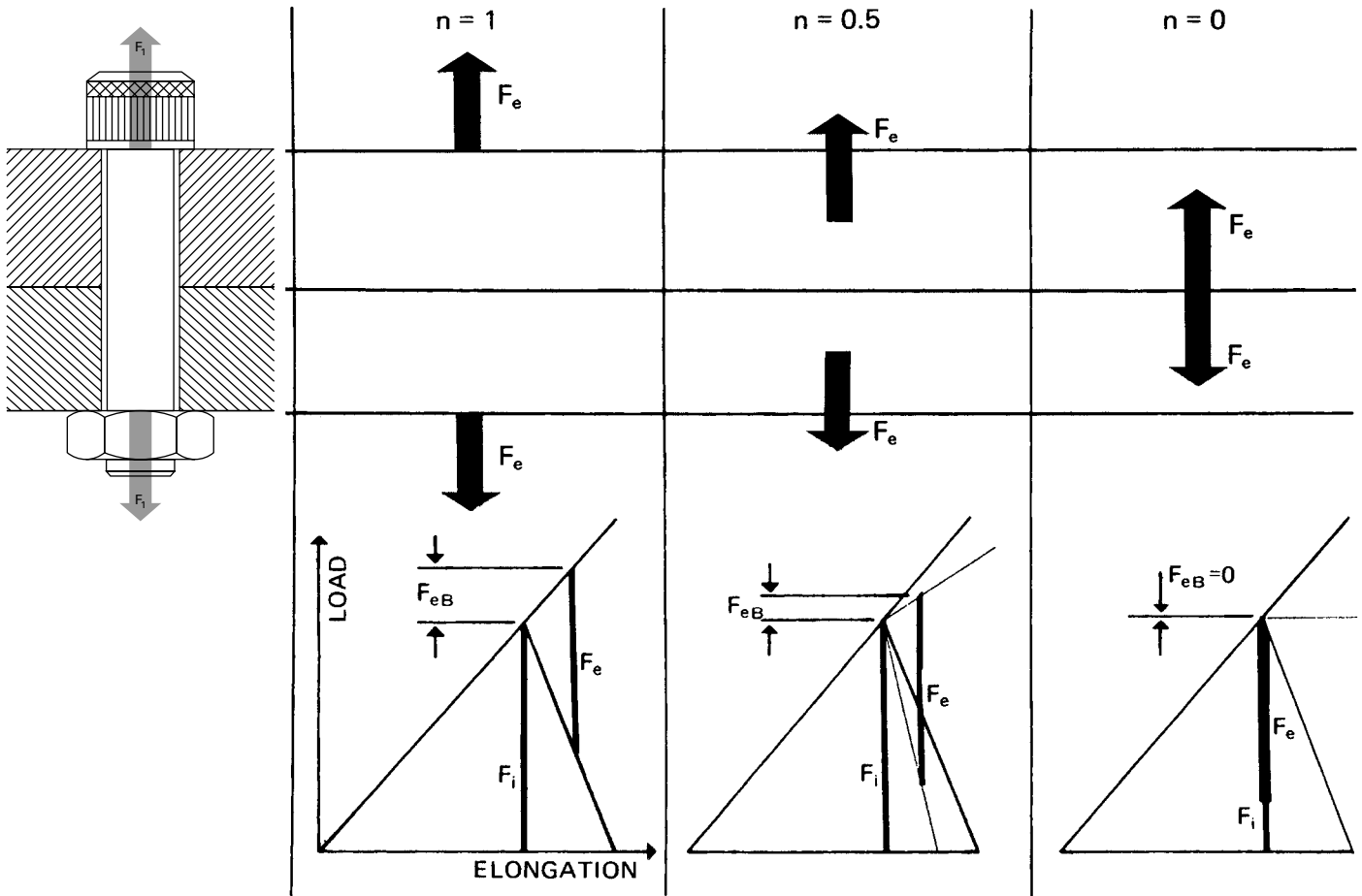

Fig. 10 Force diagrams show the effect of the loading planes of the external load on the bolt load.

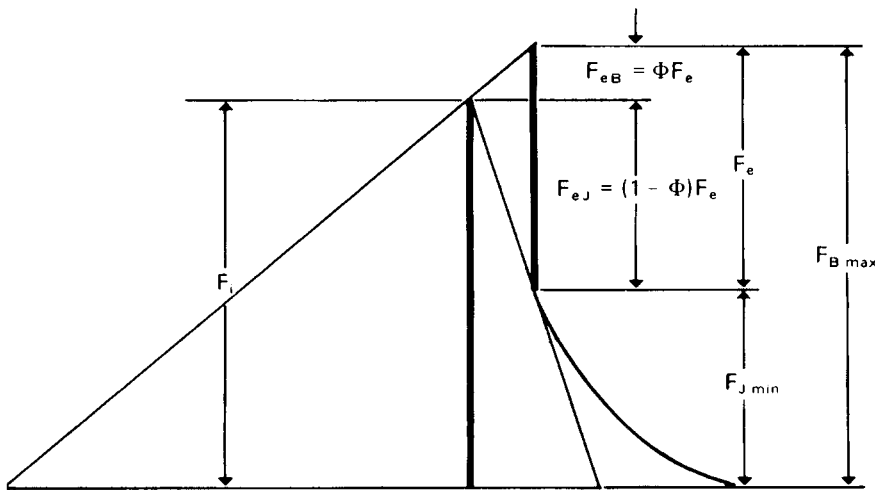

Fig. 11 Modified joint diagram shows nonlinear compression of joint at low preloads.

$F_{eB} = \Phi F_e$ must be modified to :

$$F_{eB} = n \Phi F_e$$

where n equals the ratio of the length of the clamped parts due to F_e to the joint length l_j . The value of n can range from 1, when F_e is applied under the head and nut, to 0, when F_e is applied at the joint center. Consequently the stress amplitude:

$$\sigma_B = \pm \frac{\Phi F_e}{2 A_m} \text{ becomes}$$

$$\sigma_B = \pm \frac{n \Phi F_e}{2 A_m}$$

General Design Formulae

Hitherto, construction of the joint diagram has assumed linear resilience of both bolt and joint members. However, recent investigations have shown that this assumption is not quite true for compressed parts.

Taking these investigations into account, the joint diagram is modified to Fig. 11. The lower portion of the joint spring rate is nonlinear, and the length of the linear portion depends on the preload level F_i . The higher F_i the longer the linear portion. By choosing a sufficiently high minimum load, $F_{i \min} > 2F_e$, the non-linear range of the joint spring rate is avoided and a linear relationship between F_{eB} and F_e is maintained.

Also from Fig. 11 this formula is derived:

$$F_{i \min} = F_{J \min} + (1 - \Phi) F_e + \Delta F_i$$

where ΔF_i is the amount of preload loss to be expected. For a properly designed joint, a preload loss $\Delta F_i = - (0.005 \text{ to } 0.10) F_i$ should be expected.

The fluctuation in bolt load that results from tightening is expressed by the ratio:

$$a = \frac{F_{i \max}}{F_{i \min}}$$

where a varies between 1.25 and 3.0 depending on the tightening method.

Considering the general design formulae are:

$$F_{i \text{ nom}} = F_{J \min} = (1 - \Phi) F_e$$

$$F_{i \max} = a [F_{J \min} + (1 - \Phi) F_e + \Delta F_i]$$

$$F_{B \max} = a [F_{J \min} + (1 - \Phi) F_e + \Delta F_i] + \Phi F_e$$

Conclusion

The three requirements of concentrically loaded joints that must be met for an integral bolted joint are:

1. The maximum bolt load $F_{B \max}$ must be less than the bolt yield strength.
2. If the external load is alternating, the alternating stress must be less than the bolt endurance limit to avoid fatigue failures.
3. The joint will not lose any preload due to permanent set or vibration greater than the value assumed for ΔF_i .

SYMBOLS

A	Area (in. ²)	$F_{B \max}$	Maximum Bolt load (lb)
A_m	Area of minor thread diameter (in. ²)	$F_{J \min}$	Minimum Joint load (lb)
A_s	Area of substitute cylinder (in. ²)	K	Spring rate (lb/in.)
A_x	Area of bolt part 1_x (in. ²)	K_B	Spring rate of Bolt (lb/in.)
d	Diameter of minor thread (in.)	K_J	Spring rate of Joint (lb/in.)
D_c	Outside diameter of bushing (cylinder) (in.)	K_x	Spring rate of Bolt part 1_x (lb/in.)
D_H	Diameter of Bolt head (in.)	l	Length (in.)
D_h	Diameter of hole (in.)	Δl	Change in length (in.)
D_J	Diameter of Joint	l_B	Length of Bolt (in.)
E	Modulus of Elasticity (psi)	Δl_B	Bolt elongation due to F_i (in.)
F	Load (lb)	l_J	Length of Joint (in.)
F_e	External load (lb.)	Δl_J	Joint compression to F_i (in.)
F_{eB}	Additional Bolt Load due to external load (lb)	l_x	Length of Bolt part x (in.)
F_{eJ}	Reduced Joint load due to external load (lb)	n	$\frac{\text{Length of clamped parts}}{\text{Total Joint Length}}$
F_i	Preload on Bolt and Joint (lb)	α	Tightening factor
ΔF_i	Preload loss (-lb)	Φ	Force ratio
$F_{i \min}$	Minimum preload (lb)	λ	Bolt and Joint elongation due to F_e (in.)
$F_{i \max}$	Maximum preload (lb)	σ_B	Bolt stress amplitude (\pm psi)
$F_{j \text{ nom}}$	Nominal preload (lb)		

TIGHTENING TORQUES AND THE TORQUE-TENSION RELATIONSHIP

All of the analysis and design work done in advance will have little meaning if the proper preload is not achieved. Several discussions in this technical section stress the importance of preload to maintaining joint integrity. There are many methods for measuring preload (see Table 12). However, one of the least expensive techniques that provides a reasonable level of accuracy versus cost is by measuring torque. The fundamental characteristic required is to know the relationship between torque and tension for any particular bolted joint. Once the desired design preload must be identified and specified first, *then* the torque required to induce that preload is determined.

Within the elastic range, before permanent stretch is induced, the relationship between torque and tension is essentially linear (see figure 13). Some studies have found up to 75 variables have an effect on this relationship: materials, temperature, rate of installation, thread helix angle, coefficients of friction, etc. One way that has been developed to reduce the complexity is to depend on empirical test results. That is, to perform experiments under the application conditions by measuring the induced torque and recording the resulting tension. This can be done with relatively simple, calibrated hydraulic pressure sensors, electric strain gages, or piezoelectric load cells. Once the data is gathered and plotted on a chart, the slope of the curve can be used to calculate a correlation factor. This technique has created an accepted formula for relating torque to tension.

$$T = K \times D \times P$$

T = torque, lbf.-in.

D = fastener nominal diameter, inches

P = preload, lbf.

K = "nut factor," "tightening factor," or "k-value"

If the preload and fastener diameter are selected in the design process, and the K-value for the application conditions is known, then the necessary torque can be calculated. It is noted that even with a specified torque, actual conditions at the time of installation can result in variations in the actual preload achieved (see Table 12).

One of the most critical criteria is the selection of the K-value. Accepted nominal values for many industrial applications are:

K = 0.20 for as-received steel bolts into steel holes

K = 0.15 steel bolts with cadmium plating, which acts like a lubricant,

K = 0.28 steel bolts with zinc plating.

The K-value is not the coefficient of the friction (μ); it is an empirically derived correlation factor.

It is readily apparent that if the torque intended for a zinc plated fastener is used for cadmium plated fastener, the preload will be almost two times that intended; it may actually cause the bolt to break.

Another influence is where friction occurs. For steel bolts holes, approximately 50% of the installation torque is consumed by friction under the head, 35% by thread friction, and only the remaining 15% inducing preload tension. Therefore, if lubricant is applied just on the

fastener underhead, full friction reduction will not be achieved. Similarly, if the material against which the fastener is bearing, e.g. aluminum, is different than the internal thread material, e.g. cast iron, the effective friction may be difficult to predict. These examples illustrate the importance and the value of identifying the torque-tension relationship. It is a recommend practice to contact the lubricant manufacturer for K-value information if a lubricant will be used.

The recommended seating torques for Unbrako headed socket screws are based on inducing preloads reasonably expected in practice for each type. The values for Unbrako metric fasteners are calculated using VDI2230, a complex method utilized extensively in Europe. All values assume use in the received condition in steel holes. It is understandable the designer may need preloads higher than those listed. The following discussion is presented for those cases.

TORSION-TENSION YIELD AND TENSION CAPABILITY AFTER TORQUING

Once a headed fastener has been seated against a bearing surface, the inducement of torque will be translated into both torsion and tension stresses. These stresses combine to induce twist. If torque continues to be induced, the stress along the angle of twist will be the largest stress *while the bolt is being torqued*. Consequently, the stress along the bolt axis (axial tension) will be something less. This is why a bolt can fail at a lower tensile stress *during installation* than when it is pulled in straight tension alone, eg . a tensile test. Research has indicated the axial tension can range from 135,000 to 145,000 PSI for industry socket head cap screws at torsion-tension yield, depending on diameter. Including the preload variation that can occur with various installation techniques, eg. up to 25%, it can be understood why some recommended torques induce preload reasonably lower than the yield point.

Figure 13 also illustrates the effect of straight tension applied after installation has stopped. Immediately after stopping the installation procedure there will be some relaxation, and the torsion component will drop toward zero. This leaves only the axial tension, which keeps the joint clamped together. Once the torsion is relieved, the axial tension yield value and ultimate value for the fastener will be appropriate.

Table 12
Industrial Fasteners Institute's
Torque-Measuring Method

Preload Measuring Method	Accuracy Percent	Relative Cost
Feel (operator's judgement)	±35	1
Torque wrench	±25	1.5
Turn of the nut	±15	3
Load-indicating washers	±10	7
Fastener elongation	±3 to 5	15
Strain gages	±1	20

THE TORQUE-TENSION RELATIONSHIP

Fig. 14

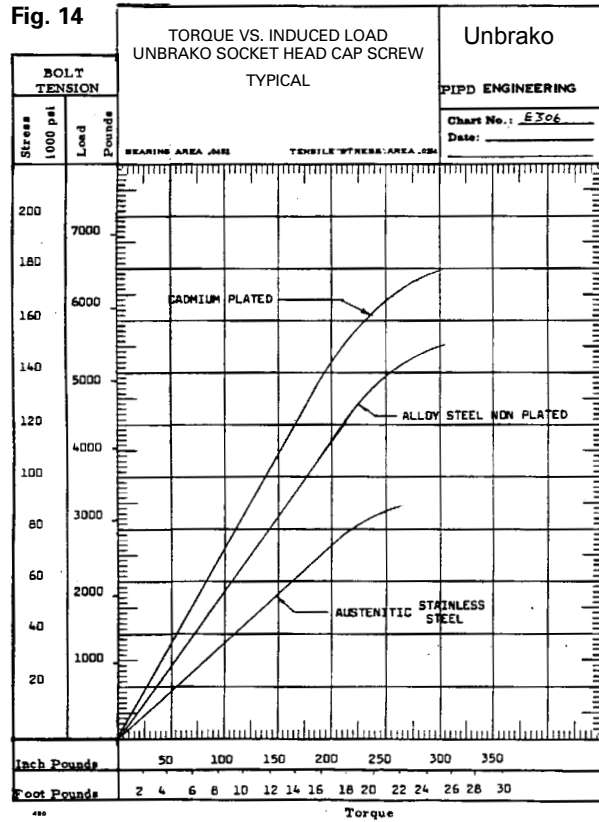

Fig. 13 Torque/Tension Relationship

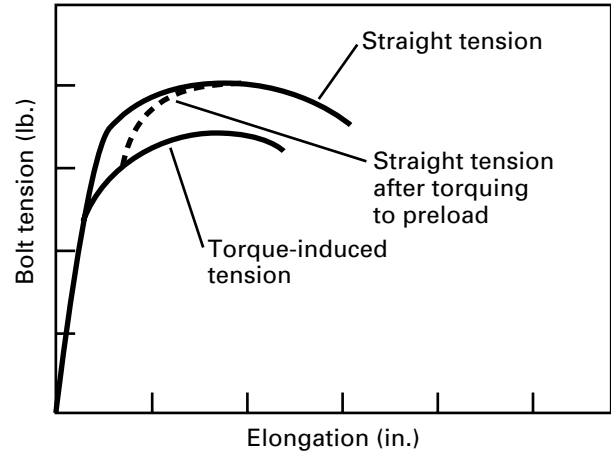

Fig. 15 Recommended Seating Torques (Inch-Lb.) for Application in Various Materials UNBRAKO pHd (1960 Series) Socket Head Cap Screws

screw size	mild steel Rb 87 cast iron Rb 83 note 1		brass Rb 72 note 2		aluminum Rb 72 (2024-T4) note 3	
	UNC	UNF	UNC	UNF	UNC	UNF
	plain	plain	plain	plain	plain	plain
#0	—	*2.1	—	*2.1	—	*2.1
#1	*3.8	*4.1	*3.8	*4.1	*3.8	*4.1
#2	*6.3	*6.8	*6.3	*6.8	*6.3	*6.8
#3	*9.6	*10.3	*9.6	*10.3	*9.6	*10.3
#4	*13.5	*14.8	*13.5	*14.8	*13.5	*14.8
#5	*20	*21	*20	*21	*20	*21
#6	*25	*28	*25	*28	*25	*28
#8	*46	*48	*46	*48	*46	*48
#10	*67	*76	*67	*76	*67	*76
1/4	*158	*180	136	136	113	113
5/16	*326	*360	228	228	190	190
3/8	*580	635	476	476	397	397
7/16	*930	*1,040	680	680	570	570
1/2	*1,420	*1,590	1,230	1,230	1,030	1,030
9/16	*2,040	2,250	1,690	1,690	1,410	1,410
5/8	*2,820	3,120	2,340	2,340	1,950	1,950
3/4	*5,000	5,340	4,000	4,000	3,340	3,340
7/8	*8,060	8,370	6,280	6,280	5,230	5,230
1	*12,100	12,800	9,600	9,600	8,000	8,000
1 1/8	*13,800	*15,400	13,700	13,700	11,400	11,400
1 1/4	*19,200	*21,600	18,900	18,900	15,800	15,800
1 3/8	*25,200	*28,800	24,200	24,200	20,100	20,100
1 1/2	*33,600	*36,100	32,900	32,900	27,400	27,400

NOTES:

1. Torques based on 80,000 psi bearing stress under head of screw.
2. Torques based on 60,000 psi bearing stress under head of screw.
3. Torques based on 50,000 psi bearing stress under head of screw.

*Denotes torques based on 100,000 psi tensile stress in screw threads up to 1" dia., and 80,000 psi for sizes 1 1/8" dia. and larger.

To convert inch-pounds to inch-ounces – multiply by 16.

To convert inch-pounds to foot-pounds – divide by 12.

STRIPPING STRENGTH OF TAPPED HOLES

Charts and sample problems for obtaining minimum thread engagement based on applied load, material, type of thread and bolt diameter.

Knowledge of the thread stripping strength of tapped holes is necessary to develop full tensile strength of the bolt or, for that matter, the minimum engagement needed for any lesser load.

Conversely, if only limited length of engagement is available, the data help determine the maximum load that can be safely applied without stripping the threads of the tapped hole.

Attempts to compute lengths of engagement and related factors by formula have not been entirely satisfactory—mainly because of subtle differences between various materials. Therefore, strength data has been empirically developed from a series of tensile tests of tapped specimens for seven commonly used metals including steel, aluminum, brass and cast iron.

The design data is summarized in the six accompanying charts, (Charts E504-E509), and covers a range of screw thread sizes from #0 to one inch in diameter for both coarse and fine threads. Though developed from tests of Unbrako socket head cap screws having minimum ultimate tensile strengths (depending on the diameter) from 190,000 to 180,000 psi, these stripping strength values are valid for all other screws or bolts of equal or lower strength having a standard thread form. Data are based on static loading only.

In the test program, bolts threaded into tapped specimens of the metal under study were stressed in tension until the threads stripped. Load at which stripping occurred and the length of engagement of the specimen were noted. Conditions of the tests, all of which are met in a majority of industrial bolt applications, were:

- Tapped holes had a basic thread depth within the range of 65 to 80 per cent. Threads of tapped holes were Class 2B fit or better.
- Minimum amount of metal surrounding the tapped hole was 2 1/2 times the major diameter.
- Test loads were applied slowly in tension to screws having standard Class 3A threads. (Data, though, will be equally applicable to Class 2A external threads as well.)
- Study of the test results revealed certain factors that greatly simplified the compilation of thread stripping strength data:
- Stripping strengths are almost identical for loads applied either by pure tension or by screw torsion. Thus data are equally valid for either condition of application.

- Stripping strength values vary with diameter of screw. For a given load and material, larger diameter bolts required greater engagement.
- Minimum length of engagement (as a percent of screw diameter) is a straight line function of load. This permits easy interpolation of test data for any intermediate load condition.
- When engagement is plotted as a percentage of bolt diameter, it is apparent that stripping strengths for a wide range of screw sizes are close enough to be grouped in a single curve. Thus, in the accompanying charts, data for sizes #0 through #12 have been represented by a single set of curves.

With these curves, it becomes a simple matter to determine stripping strengths and lengths of engagement for any condition of application. A few examples are given below:

Example 1. Calculate length of thread engagement necessary to develop the minimum ultimate tensile strength (190,000 psi) of a 1/2-13 (National Coarse) Unbrako cap screw in cast iron having an ultimate shear strength of 30,000 psi. E505 is for screw sizes from #0 through #10; E506 and E507 for sizes from 1/4 in. through 5/8 in.; E508 and E509 for sizes from 3/4 in. through 1 in. Using E506 a value 1.40D is obtained. Multiplying nominal bolt diameter (0.500 in.) by 1.40 gives a minimum length of engagement of 0.700 in.

Example 2. Calculate the length of engagement for the above conditions if only 140,000 psi is to be applied. (This is the same as using a bolt with a maximum tensile strength of 140,000psi.) From E506 obtain value of 1.06D. Minimum length of engagement = (0.500) (1.06) = 0.530.

Example 3. Suppose in Example 1 that minimum length of engagement to develop full tensile strength was not available because the thickness of metal allowed a tapped hole of only 0.600 in. Hole depth in terms of bolt dia. = $0.600/0.500 = 1.20D$. By working backwards in Chart E506, maximum load that can be carried is approximately 159,000 psi.

Example 4. Suppose that the hole in Example 1 is to be tapped in steel having an ultimate shear strength 65,000 psi. There is no curve for this steel in E506 but a design value can be obtained by taking a point midway between curves for the 80,000 psi and 50,000 psi steels that are listed. Under the conditions of the example, a length of engagement of 0.825D or 0.413 in. will be obtained.

STRIPPING STRENGTH OF TAPPED HOLES

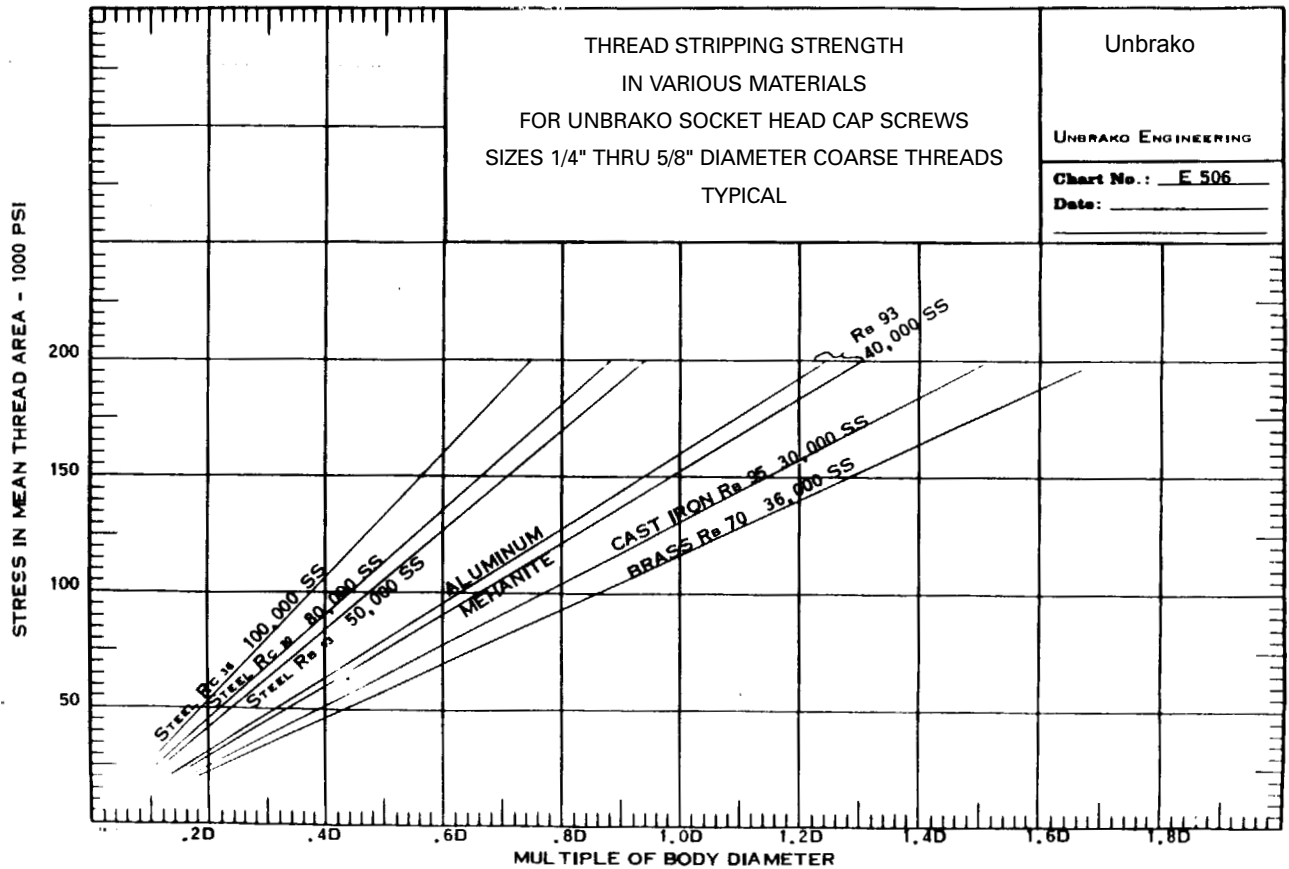
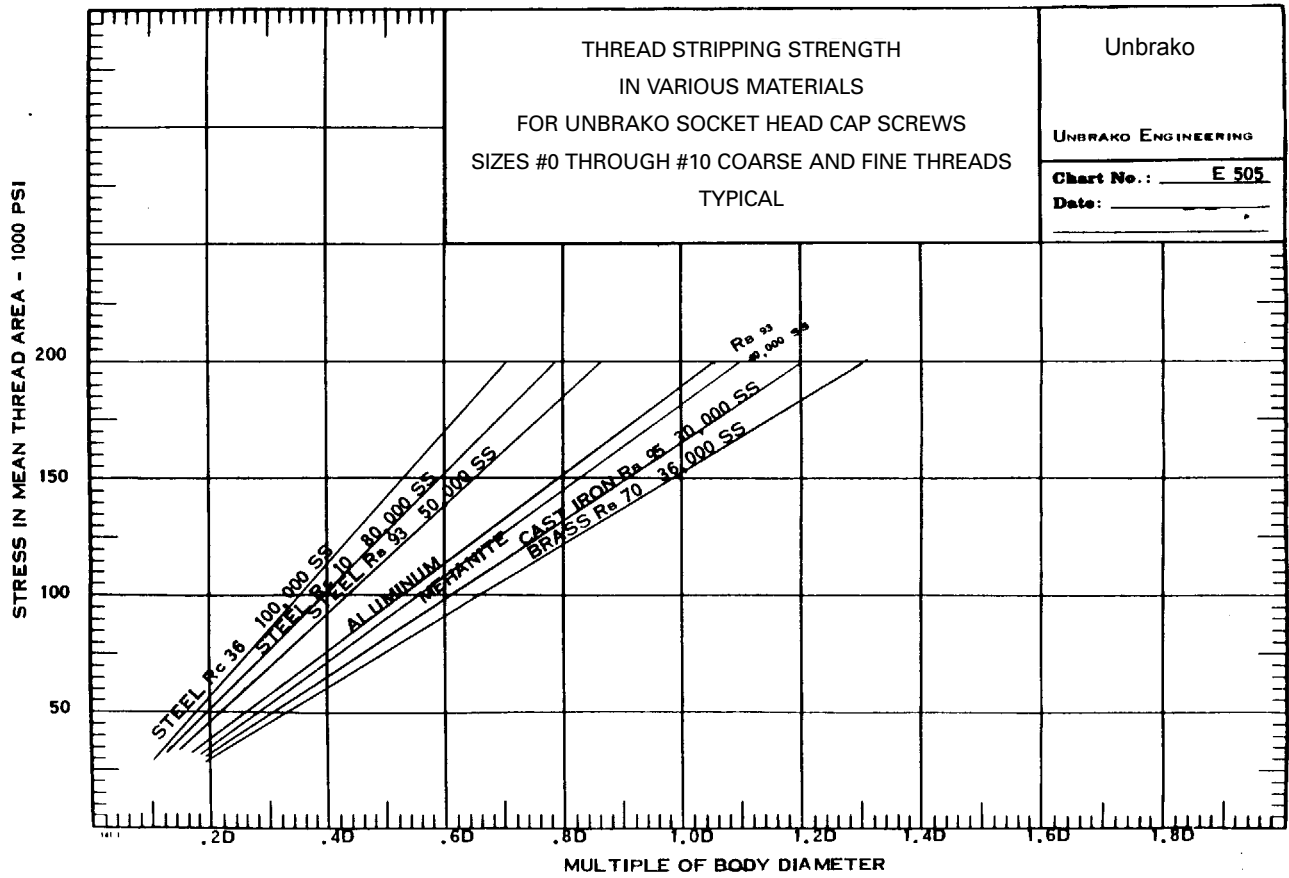

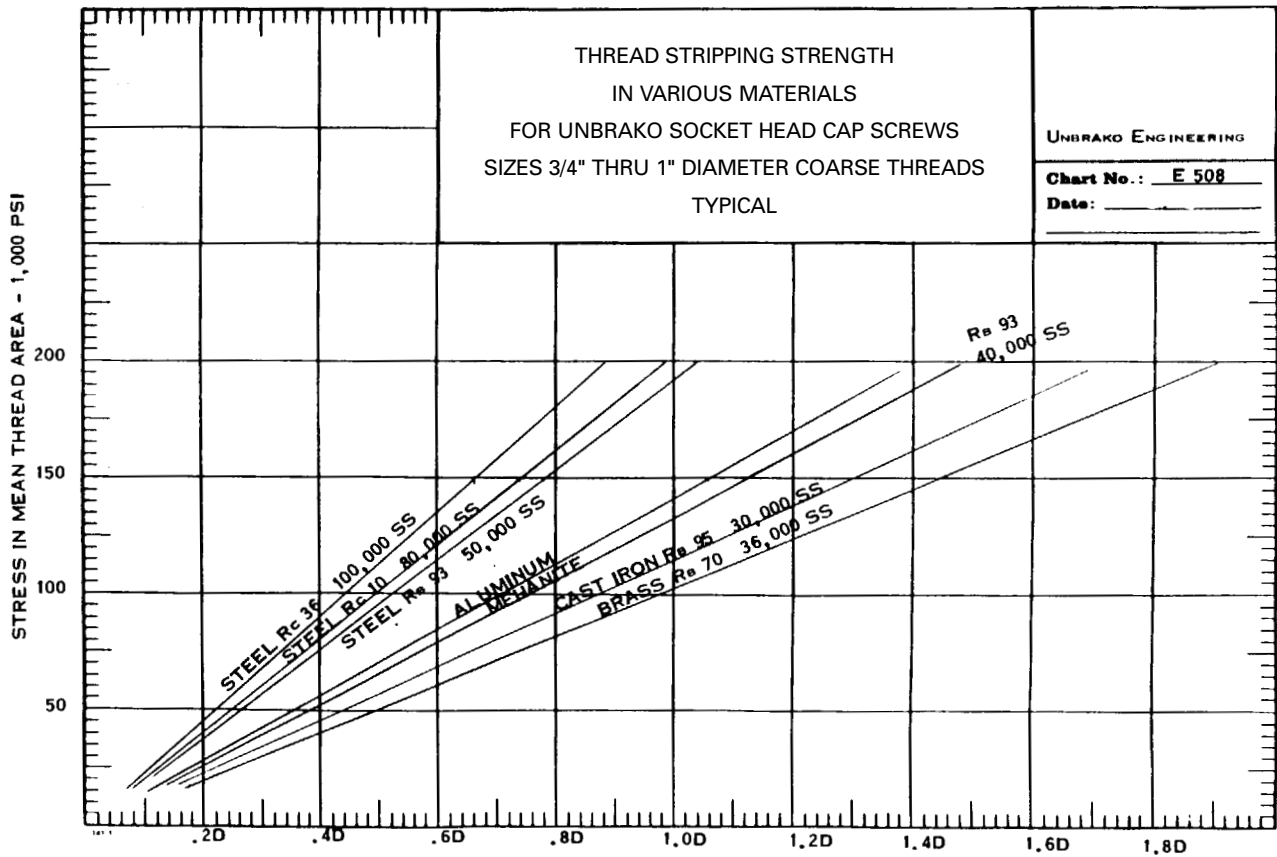
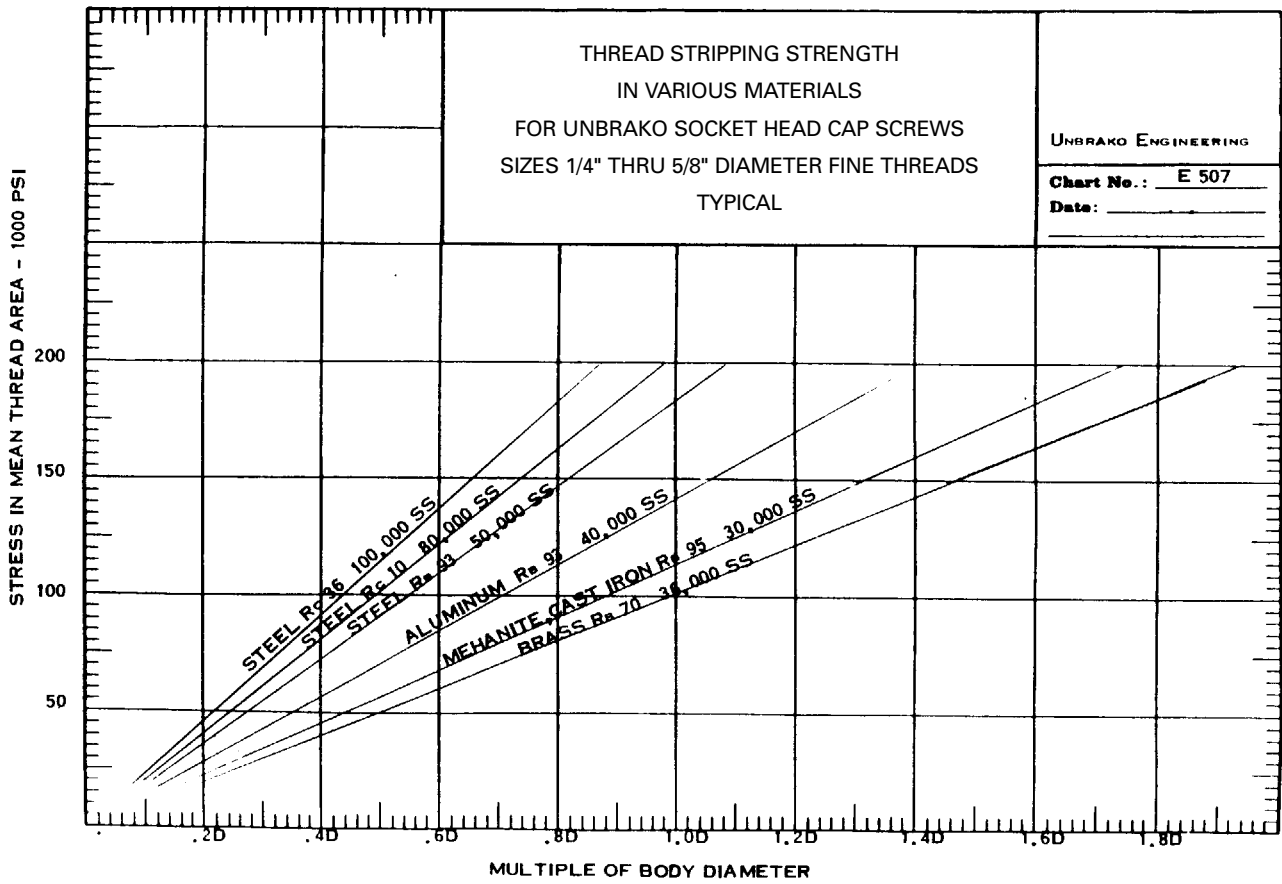

STRIPPING STRENGTH OF TAPPED HOLES

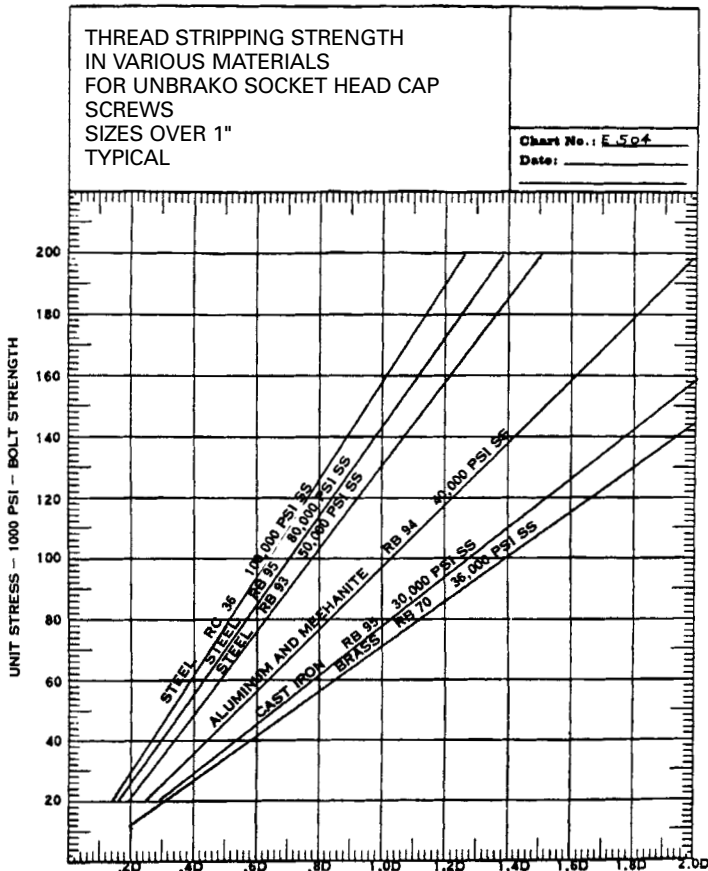
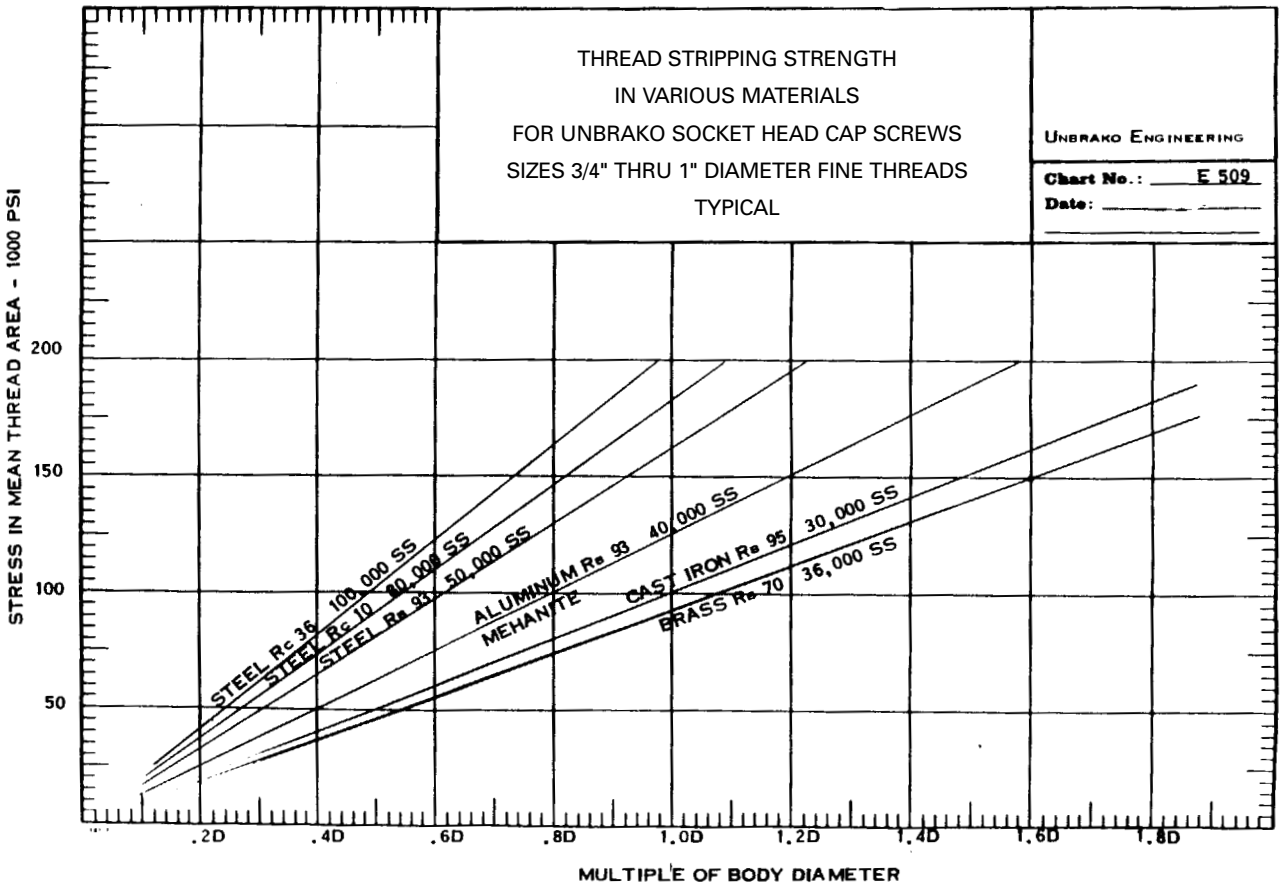

HIGH-TEMPERATURE JOINTS

Bolted joints subjected to cyclic loading perform best if an initial preload is applied. The induced stress minimizes the external load sensed by the bolt, and reduces the chance of fatigue failure. At high temperature, the induced load will change, and this can adversely affect the fastener performance. It is therefore necessary to compensate for high-temperature conditions when assembling the joint at room temperature. This article describes the factors which must be considered and illustrates how a high-temperature bolted joint is designed.

In high-temperature joints, adequate clamping force or preload must be maintained in spite of temperature-induced dimensional changes of the fastener relative to the joint members. The change in preload at any given temperature for a given time can be calculated, and the effect compensated for by proper fastener selection and initial preload.

Three principal factors tend to alter the initial clamping force in a joint at elevated temperatures, provided that the fastener material retains requisite strength at the elevated temperature. These factors are: Modulus of elasticity, coefficient of thermal expansion, and relaxation.

Modulus Of Elasticity: As temperature increases, less stress or load is needed to impart a given amount of elongation or strain to a material than at lower temperatures. This means that a fastener stretched a certain amount at room temperature to develop a given preload will exert a lower clamping force at higher temperature if there is no change in bolt elongation.

Coefficient of Expansion: With most materials, the size of the part increases as the temperature increases. In a joint, both the structure and the fastener grow with an increase in temperature, and this can result, depending on the materials, in an increase or decrease in the clamping force. Thus, matching of materials in joint design can assure sufficient clamping force at both room and elevated temperatures. Table 16 lists mean coefficient of thermal expansion of certain fastener alloys at several temperatures.

Relaxation: At elevated temperatures, a material subjected to constant stress below its yield strength will flow plastically and permanently change size. This phenomenon is called creep. In a joint at elevated temperature, a fastener with a fixed distance between the bearing surface of the head and nut will produce less and less clamping force with time. This characteristic is called relaxation. It differs from creep in that stress changes while elongation or strain remains constant. Such elements as material, temperature, initial stress, manufacturing method, and design affect the rate of relaxation.

Relaxation is the most important of the three factors. It is also the most critical consideration in design of elevated-temperature fasteners. A bolted joint at 1200°F can lose as much as 35 per cent of preload. Failure to compensate for this could lead to fatigue failure through a loose joint even though the bolt was properly tightened initially.

If the coefficient of expansion of the bolt is greater than that of the joined material, a predictable amount of clamping force will be lost as temperature increases. Conversely, if the coefficient of the joined material is greater, the bolt may be stressed beyond its yield or even fracture strength. Or, cyclic thermal stressing may lead to thermal fatigue failure.

Changes in the modulus of elasticity of metals with increasing temperature must be anticipated, calculated, and compensated for in joint design. Unlike the coefficient of expansion, the effect of change in modulus is to reduce clamping force whether or not bolt and structure are the same material, and is strictly a function of the bolt metal.

Since the temperature environment and the materials of the structure are normally "fixed," the design objective is to select a bolt material that will give the desired clamping force at all critical points in the operating range of the joint. To do this, it is necessary to balance out the three factors—relaxation, thermal expansion, and modulus—with a fourth, the amount of initial tightening or clamping force.

In actual joint design the determination of clamping force must be considered with other design factors such as ultimate tensile, shear, and fatigue strength of the fastener at elevated temperature. As temperature increases the inherent strength of the material decreases. Therefore, it is important to select a fastener material which has sufficient strength at maximum service temperature.

Example

The design approach to the problem of maintaining satisfactory elevated-temperature clamping force in a joint can be illustrated by an example. The example chosen is complex but typical. A cut-and-try process is used to select the right bolt material and size for a given design load under a fixed set of operating loads and environmental conditions, Fig. 17.

The first step is to determine the change in thickness, Δt , of the structure from room to maximum operating temperature.

For the AISI 4340 material:

$$\Delta t_1 = t_1(T_2 - T_1)\alpha$$

$$\Delta t_1 = (0.50)(800 - 70)(7.4 \times 10^{-6})$$

$$\Delta t_1 = 0.002701 \text{ in.}$$

For the AMS 6304 material:

$$\Delta t_2 = (0.75)(800 - 70)(7.6 \times 10^{-6})$$

$$\Delta t_2 = 0.004161 \text{ in.}$$

The total increase in thickness for the joint members is 0.00686 in.

The total effective bolt length equals the total joint thickness plus one-third of the threads engaged by the nut. If it is assumed that the smallest diameter bolt should be used for weight saving, then a 1/4-in. bolt should be tried. Thread engagement is approximately one diameter, and the effective bolt length is:

HIGH-TEMPERATURE JOINTS

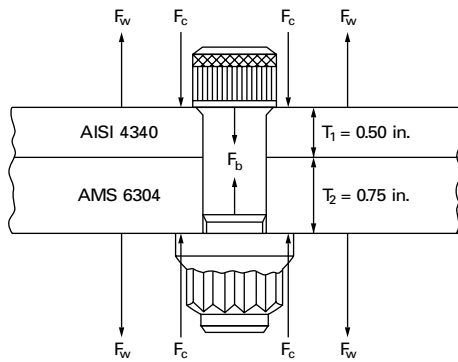

- d = Bolt diam, in. T_1 = Room temperature = 70°F
 E = Modulus of elasticity, psi T_2 = Maximum operating temperature for 1000 hr = 800°F
 F_b = Bolt preload, lb
 F_c = Clamping force, lb ($F_b = F_c$) t = Panel thickness, in.
 F_w = Working load = 1500 lb static + 100 lb cyclic a = Coefficient of thermal expansion
 L = Effective bolt length, in.

Fig. 17 – Parameters for joint operating at 800°F.

$$L = t_1 + t_2 + (1/3)d$$

$$L = 0.50 + 0.75 + (1/3 \times 0.25)$$

$$L = 1.333 \text{ in.}$$

The ideal coefficient of thermal expansion of the bolt material is found by dividing the total change in joint thickness by the bolt length times the change in temperature.

$$\alpha b = \frac{\Delta t}{L \times \Delta t}$$

$$\alpha = \frac{.00686}{(1.333)(800 - 70)} = 7.05 \times 10^{-6} \text{ in./in./deg. F}$$

The material, with the nearest coefficient of expansion is with a value of 9,600,000 at 800°F.

To determine if the bolt material has sufficient strength and resistance to fatigue, it is necessary to calculate the stress in the fastener at maximum and minimum load. The bolt load plus the cyclic load divided by the tensile stress of the threads will give the maximum stress. For a 1/4-28 bolt, tensile stress area, from thread handbook H 28, is 0.03637 sq. in. The maximum stress is

$$S_{max} = \frac{\text{Bolt load}}{\text{Stress area}} = \frac{1500 + 100}{0.03637}$$

$$S_{max} = 44,000 \text{ psi}$$

and the minimum bolt stress is 41,200 psi.

H-11 has a yield strength of 175,000 psi at 800°F, Table 3, and therefore should be adequate for the working loads.

A Goodman diagram, Fig. 18, shows the extremes of stress within which the H-11 fastener will not fail by fatigue. At the maximum calculated load of 44,000 psi, the fastener will withstand a minimum cyclic loading at 800°F of about 21,000 psi without fatigue failure.

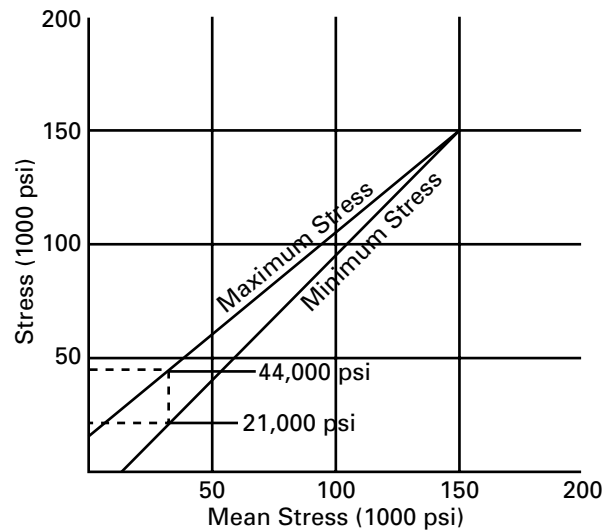

Fig. 18 – Goodman diagram of maximum and minimum operating limits for H-11 fastener at 800°F. Bolts stressed within these limits will give infinite fatigue life.

Because of relaxation, it is necessary to determine the initial preload required to insure 1500-lb. clamping force in the joint after 1000 hr at 800°F.

When relaxation is considered, it is necessary to calculate the maximum stress to which the fastener is subjected. Because this stress is not constant in dynamic joints, the resultant values tend to be conservative. Therefore, a maximum stress of 44,000 psi should be considered although the necessary stress at 800°F need be only 41,200 psi. Relaxation at 44,000 psi can be interpolated from the figure, although an actual curve could be constructed from tests made on the fastener at the specific conditions.

The initial stress required to insure a clamping stress of 44,000 psi after 1000 hr at 800°F can be calculated by interpolation.

$$x = 61,000 - 44,000 = 17,000$$

$$y = 61,000 - 34,000 = 27,000$$

$$B = 80,000 - 50,000 = 30,000$$

$$A = 80,000 - C$$

$$\frac{x}{y} = \frac{A}{B} \quad \frac{17,000}{27,000} = \frac{80,000 - C}{30,000}$$

$$C = 61,100 \text{ psi}$$

The bolt elongation required at this temperature is calculated by dividing the stress by the modulus at temperature and multiplying by the effective length of the bolt. That is: $(61,000 \times 1.333) / 24.6 \times 10^6 = 0.0033$

Since the joint must be constructed at room temperature, it is necessary to determine the stresses at this state. Because the modulus of the fastener material changes with temperature, the clamping force at room temperature will not be the same as at 800°F. To deter-

mine the clamping stress at assembly conditions, the elongation should be multiplied by the modulus of elasticity at room temperature.

$$.0033 \times 30.6 \times 10^6 = 101,145 \text{ psi}$$

The assembly conditions will be affected by the difference between the ideal and actual coefficients of expansion of the joint. The ideal coefficient for the fastener material was calculated to be 7.05 but the closest material – H-11 – has a coefficient of 7.1. Since this material has a greater expansion than calculated, there will be a reduction in clamping force resulting from the increase in temperature. This amount equals the difference between the ideal and the actual coefficients multiplied by the change in temperature, the length of the fastener, and the modulus of elasticity at 70°F.

$$[(7.1 - 7.05) \times 10^{-6}][800 - 70][1.333] \times [30.6 \times 10^6] = 1,490 \text{ psi}$$

The result must be added to the initial calculated stresses to establish the minimum required clamping stress needed for assembling the joint at room temperature.

$$101,145 + 1,490 = 102,635 \text{ psi}$$

Finally, the method of determining the clamping force or preload will affect the final stress in the joint at operating conditions. For example, if a torque wrench is

used to apply preload (the most common and simplest method available), a plus or minus 25 per cent variation in induced load can result. Therefore, the maximum load which could be expected in this case would be 1.5 times the minimum, or:

$$(1.5)(102,635) = 153,950 \text{ psi}$$

This value does not exceed the room-temperature yield strength for H-11 given in Table 19.

Since there is a decrease in the clamping force with an increase in temperature and since the stress at operating temperature can be higher than originally calculated because of variations in induced load, it is necessary to ascertain if yield strength at 800°F will be exceeded

$$\frac{(\text{max stress at } 70^\circ\text{F} + \text{change in stress}) \times E \text{ at } 800^\circ\text{F}}{E \text{ at } 70^\circ\text{F}}$$

$$\frac{[153,950 + (-1490)] \times 24.6 \times 10^6}{30.6 \times 10^6} = 122,565$$

This value is less than the yield strength for H-11 at 800°F, Table 19. Therefore, a 1/4-28 H-11 bolt stressed between 102,635 psi and 153,950 psi at room temperature will maintain a clamping load 1500 lb at 800°F after 1000 hr of operation. A cyclic loading of 100 lb, which results in a bolt loading between 1500 and 1600 lb will not cause fatigue failure at the operating conditions.

Table 16

PHYSICAL PROPERTIES OF MATERIALS USED TO MANUFACTURE ALLOY STEEL SHCS'S

Coefficient of Thermal Expansion, $\mu\text{m/m}/^\circ\text{K}^1$

20°C to 68°F to	100 212	200 392	300 572	400 752	500 932	600 1112
Material						
5137M, 51B37M ²	–	12.6	13.4	13.9	14.3	14.6
4137 ³	11.2	11.8	12.4	13.0	13.6	–
4140 ³	12.3	12.7	–	13.7	–	14.5
4340 ³	–	12.4	–	13.6	–	14.5
8735 ³	11.7	12.2	12.8	13.5	–	14.1
8740 ³	11.6	12.2	12.8	13.5	–	14.1

Modulus of Elongation (Young's Modulus)

$$E = 30,000,000 \text{ PSI/in/in}$$

NOTES:

1. Developed from ASM, Metals HDBK, 9th Edition, Vol. 1 ($^\circ\text{C} = ^\circ\text{K}$ for values listed)
2. ASME SA574
3. AISI
4. Multiply values in table by .556 for $\mu\text{in/in}/^\circ\text{F}$.

Table 19 - Yield Strength at Various Temperatures

Alloy	Temperature (F)			
	70	800	1000	1200
Stainless Steels				
Type 302	35,000	35,000	34,000	30,000
Type 403	145,000	110,000	95,000	38,000
PH 15-7 Mo	220,000	149,000	101,000	–
High Strength Iron-Base Stainless Alloys				
A 286	95,000	95,000	90,000	85,000
AMS 5616	113,000	80,000	60,000	40,000
Unitemp 212	150,000	140,000	135,000	130,000
High Strength Iron-Base Alloys				
AISI 4340	200,000	130,000	75,000	–
H-11 (AMS 6485)	215,000	175,000	155,000	–
AMS 6340	160,000	100,000	75,000	–
Nickel-Base Alloys				
Inconel X	115,000	–	–	98,000
Waspaloy	115,000	–	106,000	100,000

CORROSION IN THREADED FASTENERS

All fastened joints are, to some extent, subjected to corrosion of some form during normal service life. Design of a joint to prevent premature failure due to corrosion must include considerations of the environment, conditions of loading, and the various methods of protecting the fastener and joint from corrosion.

Three ways to protect against corrosion are:

1. Select corrosion-resistant material for the fastener.
2. Specify protective coatings for fastener, joint interfaces, or both.
3. Design the joint to minimize corrosion.

The solution to a specific corrosion problem may require using one or all of these methods. Economics often necessitate a compromise solution.

Fastener Material

The use of a suitably corrosion-resistant material is often the first line of defense against corrosion. In fastener design, however, material choice may be only one of several important considerations. For example, the most corrosion-resistant material for a particular environment may just not make a suitable fastener.

Basic factors affecting the choice of corrosion resistant threaded fasteners are:

- Tensile and fatigue strength.
- Position on the galvanic series scale of the fastener and materials to be joined.
- Special design considerations: Need for minimum weight or the tendency for some materials to gall.
- Susceptibility of the fastener material to other types of less obvious corrosion. For example, a selected material may minimize direct attack of a corrosive environment only to be vulnerable to fretting or stress corrosion.

Some of the more widely used corrosion-resistant materials, along with approximate fastener tensile strength ratings at room temperature and other pertinent properties, are listed in Table 1. Sometimes the nature of corrosion properties provided by these fastener materials is subject to change with application and other condi-

tions. For example, stainless steel and aluminum resist corrosion only so long as their protective oxide film remains unbroken. Alloy steel is almost never used, even under mildly corrosive conditions, without some sort of protective coating. Of course, the presence of a specific corrosive medium requires a specific corrosion-resistant fastener material, provided that design factors such as tensile and fatigue strength can be satisfied.

Protective Coating

A number of factors influence the choice of a corrosion-resistant coating for a threaded fastener. Frequently, the corrosion resistance of the coating is not a principal consideration. At times it is a case of economics. Often, less-costly fastener material will perform satisfactorily in a corrosive environment if given the proper protective coating.

Factors which affect coating choice are:

- Corrosion resistance
- Temperature limitations
- Embrittlement of base metal
- Effect on fatigue life
- Effect on locking torque
- Compatibility with adjacent material
- Dimensional changes
- Thickness and distribution
- Adhesion characteristics

Conversion Coatings: Where cost is a factor and corrosion is not severe, certain conversion-type coatings are effective. These include a black-oxide finish for alloy-steel screws and various phosphate base coatings for carbon and alloy-steel fasteners. Frequently, a rust-preventing oil is applied over a conversion coating.

Paint: Because of its thickness, paint is normally not considered for protective coatings for mating threaded fasteners. However, it is sometimes applied as a supplemental treatment at installation. In special cases, a fastener may be painted and installed wet, or the entire joint may be sealed with a coat of paint after installation.

TABLE 1 – TYPICAL PROPERTIES OF CORROSION RESISTANT FASTENER MATERIALS

Materials	Tensile Strength (1000 psi)	Yield Strength at 0.2% offset (1000 psi)	Maximum Service Temp (F)	Mean Coefficient of Thermal Expan. (in./in./deg F)	Density (lbs/cu in.)	Base Cost Index	Position on Galvanic Scale
Stainless Steels							
303, passive	80	40	800	10.2	0.286	Medium	8
303, passive, cold worked	125	80	800	10.3	0.286	Medium	9
410, passive	170	110	400	5.6	0.278	Low	15
431, passive	180	140	400	6.7	0.280	Medium	16
17-4 PH	200	180	600	6.3	0.282	Medium	11
17-7 PH	200	185	600	6.7	0.276	Medium	14
AM 350	200	162	800	7.2	0.282	Medium	13
15-7 Mo	200	155	600	–	0.277	Medium	12
A-286	150	85	1200	9.72	0.286	Medium	6
A-286, cold worked	220	170	1200	–	0.286	High	7

Electroplating: Two broad classes of protective electroplating are: 1. The barrier type-such as chrome plating-which sets up an impervious layer or film that is more noble and therefore more corrosion resistant than the base metal. 2. The sacrificial type, zinc for example, where the metal of the coating is less noble than the base metal of the fastener. This kind of plating corrodes sacrificially and protects the fastener.

Noble-metal coatings are generally not suitable for threaded fasteners-especially where a close-tolerance fit is involved. To be effective, a noble-metal coating must be at least 0.001 in. thick. Because of screw-thread geometry, however, such plating thickness will usually exceed the tolerance allowances on many classes of fit for screws.

Because of dimensional necessity, threaded fastener coatings, since they operate on a different principle, are effective in layers as thin as 0.0001 to 0.0002 in.

The most widely used sacrificial platings for threaded fasteners are cadmium, zinc, and tin. Frequently, the cadmium and zinc are rendered even more corrosion resistant by a post-plating chromate-type conversion treatment. Cadmium plating can be used at temperatures to 450°F. Above this limit, a nickel cadmium or nickel-zinc alloy plating is recommended. This consists of alternate deposits of the two metals which are heat-diffused into a uniform alloy coating that can be used for applications to 900°F. The alloy may also be deposited directly from the plating bath.

Fastener materials for use in the 900 to 1200°F range (stainless steel, A-286), and in the 1200° to 1800°F range (high-nickel-base super alloys) are highly corrosion resistant and normally do not require protective coatings, except under special environment conditions.

Silver plating is frequently used in the higher temperature ranges for lubrication to prevent galling and seizing, particularly on stainless steel. This plating can cause a galvanic corrosion problem, however, because of the high nobility of the silver.

Hydrogen Embrittlement: A serious problem, known as hydrogen embrittlement, can develop in plated alloy steel fasteners. Hydrogen generated during plating can diffuse into the steel and embrittle the bolt. The result is often a delayed and total mechanical failure, at tensile levels far below the theoretical strength, high-hardness structural parts are particularly susceptible to this condition. The problem can be controlled by careful selection of plating formulation, proper plating procedure, and sufficient baking to drive off any residual hydrogen.

Another form of hydrogen embrittlement, which is more difficult to control, may occur after installation. Since electrolytic cell action liberates hydrogen at the cathode, it is possible for either galvanic or concentration-cell corrosion to lead to embrittling of the bolt material.

Joint Design

Certain precautions and design procedures can be followed to prevent, or at least minimize, each of the various types of corrosion likely to attack a threaded joint. The most important of these are:

For Direct Attack: Choose the right corrosion-resistant material. Usually a material can be found that will provide the needed corrosion resistance without sacrifice of other important design requirements. Be sure that the fastener material is compatible with the materials being joined.

Corrosion resistance can be increased by using a conversion coating such as black oxide or a phosphate-base treatment. Alternatively, a sacrificial coating such as zinc plating is effective.

For an inexpensive protective coating, lacquer or paint can be used where conditions permit.

For Galvanic Corrosion: If the condition is severe, electrically insulate the bolt and joint from each other.

The fastener may be painted with zinc chromate primer prior to installation, or the entire joint can be coated with lacquer or paint.

Another protective measure is to use a bolt that is cathodic to the joint material and close to it in the galvanic series. When the joint material is anodic, corrosion will spread over the greater area of the fastened materials. Conversely, if the bolt is anodic, galvanic action is most severe.

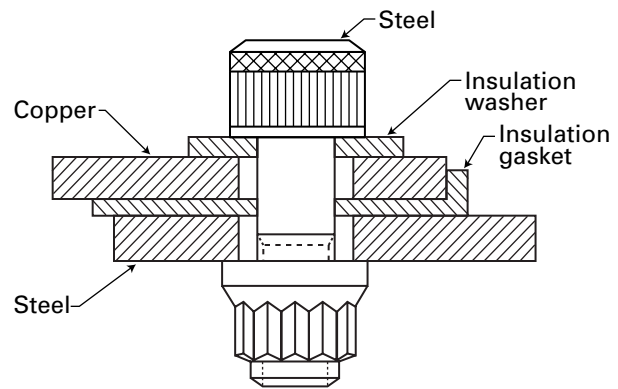

FIG. 1.1 – A method of electrically insulating a bolted joint to prevent galvanic corrosion.

For Concentration-Cell Corrosion: Keep surfaces smooth and minimize or eliminate lap joints, crevices, and seams. Surfaces should be clean and free of organic material and dirt. Air trapped under a speck of dirt on the surface of the metal may form an oxygen concentration cell and start pitting.

For maximum protection, bolts and nuts should have smooth surfaces, especially in the seating areas. Flush-head bolts should be used where possible. Further, joints can be sealed with paint or other sealant material.

For Fretting Corrosion: Apply a lubricant (usually oil) to mating surfaces. Where fretting corrosion is likely to occur: 1. Specify materials of maximum practicable hardness. 2. Use fasteners that have residual compressive stresses on the surfaces that may be under attack. 3. Specify maximum preload in the joint. A higher clamping force results in a more rigid joint with less relative movement possible between mating services.

CORROSION IN THREADED FASTENERS

For Stress Corrosion: Choose a fastener material that resists stress corrosion in the service environment. Reduce fastener hardness (if reduced strength can be tolerated), since this seems to be a factor in stress corrosion.

Minimize crevices and stress risers in the bolted joint and compensate for thermal stresses. Residual stresses resulting from sudden changes in temperature accelerate stress corrosion.

If possible, induce residual compressive stresses into the surface of the fastener by shot-peening or pressure rolling.

For Corrosion Fatigue: In general, design the joint for high fatigue life, since the principal effect of this form of corrosion is reduced fatigue performance. Factors extending fatigue performance are: 1. Application and maintenance of a high preload. 2. Proper alignment to avoid bending stresses.

If the environment is severe, periodic inspection is recommended so that partial failures may be detected before the structure is endangered.

As with stress and fretting corrosion, compressive stresses induced on the fastener surfaces by thread rolling, fillet rolling, or shot peening will reduce corrosion fatigue. Further protection is provided by surface coating.

TYPES OF CORROSION

Direct Attack...most common form of corrosion affecting all metals and structural forms. It is a direct and general chemical reaction of the metal with a corrosive medium—liquid, gas, or even a solid.

Galvanic Corrosion...occurs with dissimilar metals contact. Presence of an electrolyte, which may be nothing more than an individual atmosphere, causes corrosive action in the galvanic couple. The anodic, or less noble material, is the sacrificial element. Hence, in a joint of stainless steel and titanium, the stainless steel corrodes. One of the worst galvanic joints would consist of magnesium and titanium in contact.

Concentration Cell Corrosion...takes place with metals in close proximity and, unlike galvanic corrosion, does not require dissimilar metals. When two or more areas on the surface of a metal are exposed to different concentrations of the same solution, a difference in electrical potential results, and corrosion takes place.

If the solution consists of salts of the metal itself, a metal-ion cell is formed, and corrosion takes place on the surfaces in close contact. The corrosive solution between the two surfaces is relatively more stagnant (and thus has a higher concentration of metal ions in solution) than the corrosive solution immediately outside the crevice.

A variation of the concentration cell is the oxygen cell in which a corrosive medium, such as moist air, contains different amounts of dissolved oxygen at different points. Accelerated corrosion takes place between hidden surfaces (either under the bolt head or nut, or between bolted materials) and is likely to advance without detection.

Fretting...corrosive attack or deterioration occurring between containing, highly-loaded metal surfaces subjected to very slight (vibratory) motion. Although the mechanism is not completely understood, it is probably a highly accelerated form of oxidation under heat and stress. In threaded joints, fretting can occur between mating threads, at the bearing surfaces under the head of the screw, or under the nut. It is most likely to occur in high tensile, high-frequency, dynamic-load applications. There need be no special environment to induce this form of corrosion...merely the presence of air plus vibratory rubbing. It can even occur when only one of the materials in contact is metal.

Stress Corrosion Cracking...occurs over a period of time in high-stressed, high-strength joints. Although not fully understood, stress corrosion cracking is believed to be caused by the combined and mutually accelerating effects of static tensile stress and corrosive environment. Initial pitting somehow takes place which, in turn, further increases stress build-up. The effect is cumulative and, in a highly stressed joint, can result in sudden failure.

Corrosion Fatigue...accelerated fatigue failure occurring in the presence of a corrosive medium. It differs from stress corrosion cracking in that dynamic alternating stress, rather than static tensile stress, is the contributing agent.

Corrosion fatigue affects the normal endurance limit of the bolt. The conventional fatigue curve of a normal bolt joint levels off at its endurance limit, or maximum dynamic load that can be sustained indefinitely without fatigue failure. Under conditions of corrosion fatigue, however, the curve does not level off but continues downward to a point of failure at a finite number of stress cycles.

GALVANIC CORROSION

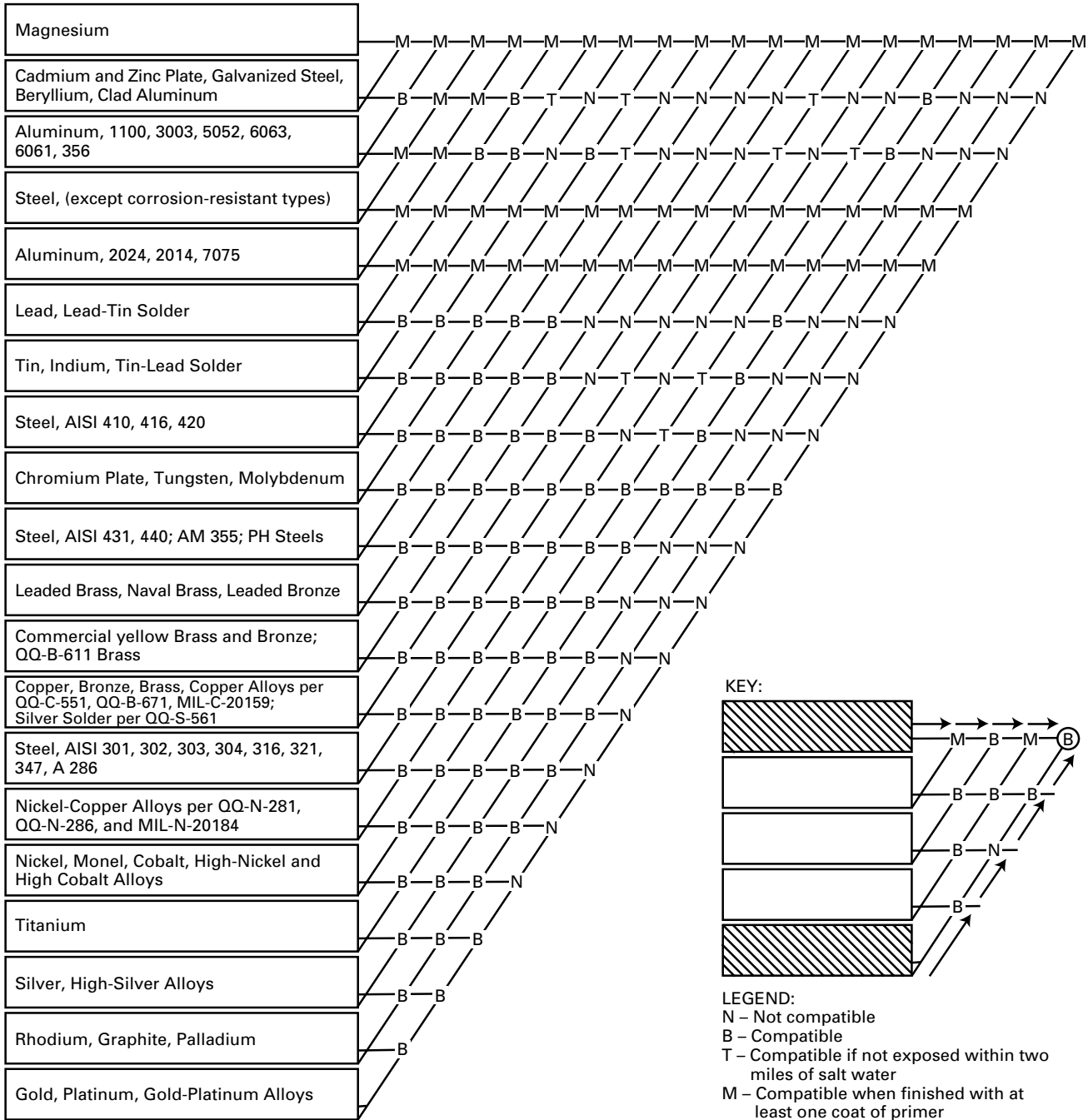

KEY:

LEGEND:
 N – Not compatible
 B – Compatible
 T – Compatible if not exposed within two miles of salt water
 M – Compatible when finished with at least one coat of primer

FIG. 19 – Metals compatibility chart

THE IMPACT PERFORMANCE OF THREADED FASTENERS

Much has been written regarding the significance of the notched bar impact testing of steels and other metallic materials. The Charpy and Izod type test relate notch behavior (brittleness versus ductility) by applying a single overload of stress. The results of these tests provide quantitative comparisons but are not convertible to energy values useful for engineering design calculations. The results of an individual test are related to that particular specimen size, notch geometry and testing conditions and cannot be generalized to other sizes of specimens and conditions.

The results of these tests are useful in determining the susceptibility of a material to brittle behavior when the applied stress is perpendicular to the major stress.

In externally threaded fasteners, however, the loading usually is applied in a longitudinal direction. The impact test, therefore, which should be applicable would be one where the applied impact stress supplements the major stress. Only in shear loading on fasteners is the major stress in the transverse direction.

Considerable testing has been conducted in an effort to determine if a relationship exists between the Charpy V notch properties of a material and the tension properties of an externally threaded fastener manufactured from the same material.

Some conclusions which can be drawn from the extensive impact testing are as follows:

1. The tension impact properties of externally threaded fasteners do not follow the Charpy V notch impact pattern.
2. Some of the variables which effect the tension impact properties are:
 - A. The number of exposed threads
 - B. The length of the fastener
 - C. The relationship of the fastener shank diameter to the thread area.
 - D. The hardness or fastener ultimate tensile strength

Following are charts showing tension impact versus Charpy impact properties, the effect of strength and diameter on tension impact properties and the effect of test temperature.

Please note from figure 21 that while the Charpy impact strength of socket head cap screw materials are decreasing at sub-zero temperatures, the tension impact strength of the same screws is increasing. This compares favorably with the effect of cryogenic temperatures on the tensile strength of the screws. Note the similar increase in tensile strength shown in figure 22.

It is recommended, therefore, that less importance be attached to Charpy impact properties of materials which are intended to be given to impact properties for threaded fasteners. If any consideration is to be given to impact properties of bolts or screws, it is advisable to investigate the tension impact properties of full size fasteners since this more closely approximates the actual application.

TABLE 20
LOW-TEMPERATURE IMPACT PROPERTIES OF SELECTED ALLOY STEELS

AISI no.	composition, %					heat temperature*		Hardness Rc	impact energy, ft.-lb					transition temp. (50% brittle) °F
						quenching temp. F+	tempering temp. F		-300°F	-200°F	-100°F	0°F	100°F	
	C	Mn	Ni	Cr	Mo									
4340	0.38	0.77	1.65	0.93	0.21	1550	400	52	11	15	20	21	21	-
							600	48	10	14	15	15	16	-
							800	44	9	13	16	21	25	-
							1000	38	15	18	28	36	36	-130
							1200	30	15	28	55	55	55	-185
4360	0.57	0.87	1.62	1.08	0.22	1475	800	48	5	6	10	11	14	-
							1000	40	9	10	13	18	23	-10
							1200	30	12	15	25	42	43	-110
4380	0.76	0.91	1.67	1.11	0.21	1450	800	49	4	5	8	9	10	-
							1000	42	8	8	10	12	15	60
							1200	31	5	11	19	33	38	-50
4620	0.20	0.67	1.85	0.30	0.18	1650	300	42	14	20	28	35	35	-
							800	34	11	16	33	55	55	-
							1000	29	16	34	55	78	78	-
							1200	19	17	48	103	115	117	-
4640	0.43	0.69	1.78	0.29	0.20	1550	800	42	16	17	20	25	27	-
							1000	37	17	22	35	39	69	-190
							1200	29	17	30	55	97	67	-180
4680	0.74	0.77	1.81	0.30	0.21	1450	800	46	5	8	13	15	16	-
							1000	41	11	12	15	19	22	-
							1200	31	11	13	17	39	43	-
8620	0.20	0.89	0.60	0.68	0.20	1650	300	43	11	16	23	35	35	-
							800	36	8	13	20	35	45	-20
							1000	29	25	33	65	76	76	-150
							1200	21	10	85	107	115	117	-195
8630	0.34	0.77	0.66	0.62	0.22	1575	800	41	7	12	17	25	31	0
							1000	34	11	20	43	53	54	-155
							1200	27	18	28	74	80	82	-165
8640	0.45	0.78	0.65	0.61	0.20	1550	800	46	5	10	14	20	23	-
							1000	38	11	15	24	40	40	-110
							1200	30	18	22	49	63	66	-140
8660	0.56	0.81	0.70	0.56	0.25	1475	800	47	4	6	10	13	16	-
							1000	41	10	12	15	20	30	-10
							1200	30	16	18	25	54	60	-90

IMPACT PERFORMANCE

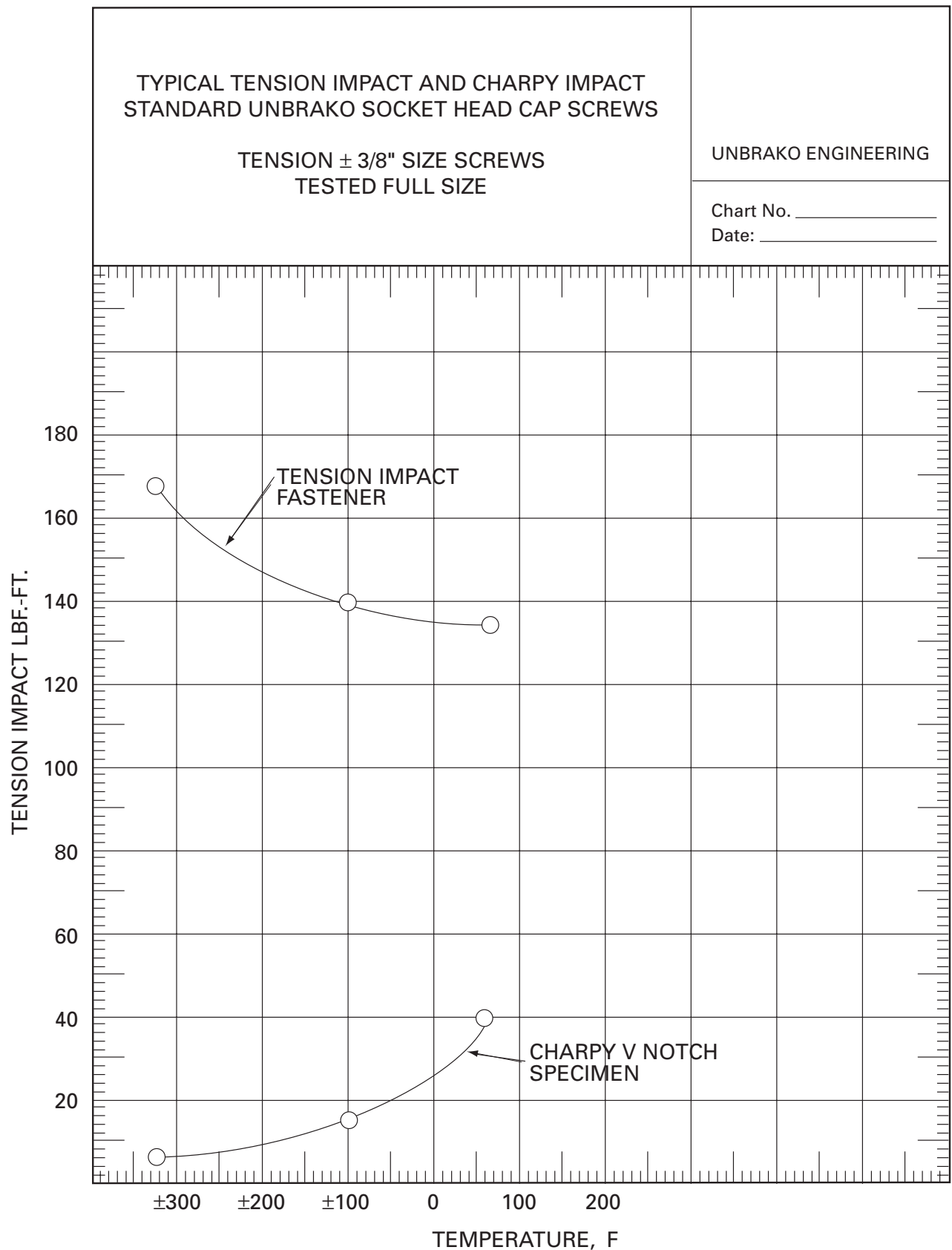

FIG. 21

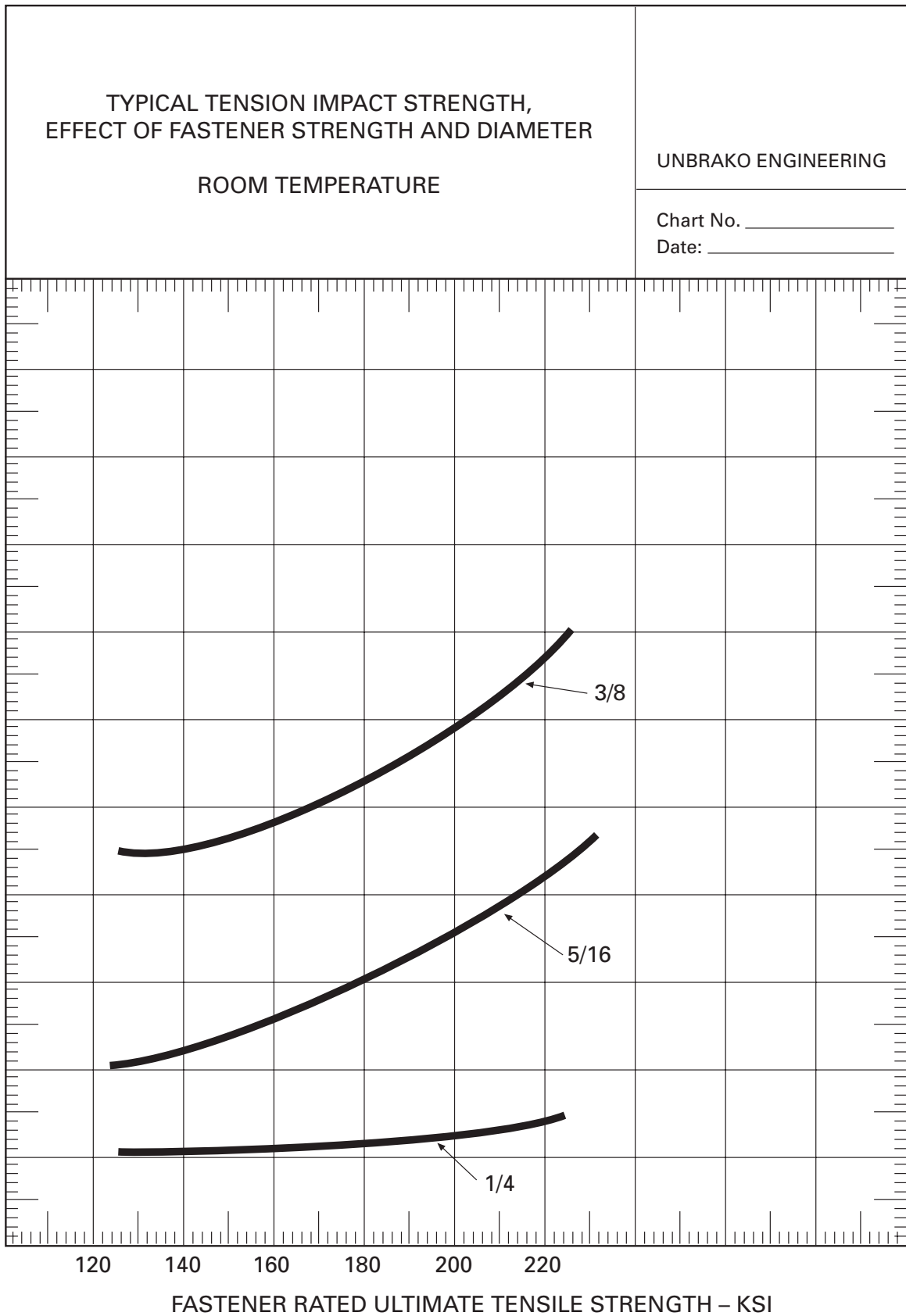

FIG. 22

PRODUCT ENGINEERING BULLETIN

UNBRAKO PRODUCT ENGINEERING BULLETIN

Standard Inch Socket Head Cap Screws Are Not Grade 8 Fasteners

There is a common, yet reasonable, misconception that standard, inch, alloy steel socket head cap screws are "Grade 8". This is not true. The misconception is reasonable because "Grade 8" is a term generally associated with "high strength" fasteners. A person desiring a "high strength" SHCS may request a "Grade 8 SHCS". This is technically incorrect for standard SHCSs. The term Grade 8 defines specific fastener characteristics which must

be met to be called "Grade 8". Three of the most important characteristics are not consistent with requirements for industry standard SHCSs: tensile strength, hardness, and head marking. Some basic differences between several fastener classifications are listed below. The list is not comprehensive but intended to provide a general understanding. SHCSs can be manufactured to meet Grade 8 requirements on a special order basis.

Fastener Designation	Grade 2	Grade 5	Grade 8	Industry SHCS	Unbrako SHCS
Applicable Standard	SAE J429	SAE J429	SAE J429	ASTM A574	ASTM A574 UNB-B-271
Strength Level, UTS KSI, min.	74 (1/4-3/4) 60 (7/8 - 1 1/2)	120 (1/4 - 1) 105 (1 1/8 - 1 1/2)	150 (1/4 - 11/2)	180 (≤1/2) 170 (> 1/2)	190 (≤ 1/2) 180 (> 1/2)
Hardness, Rockwell	B80-B100 B70-B100	C25-C34 C19-C30	C33-C39	C39-C45 C37-C45	C39-C43 C38-C43
General Material Type	Low or Medium Carbon Steel	Medium Carbon Steel	Medium Carbon Alloy Steel	Medium Carbon Alloy Steel	Medium Carbon Alloy Steel
Identification Requirement	None	Three Radial Lines	Six Radial Lines	SHCS Configuration	Mfr's ID
Typical Fasteners	Bolts Screws Studs Hex Heads	Bolts Screws Studs Hex Heads	Bolts Screws Studs Hex Heads	Socket Head Cap Screws	Socket Head Cap Screws

THREADS IN BOTH SYSTEMS

Thread forms and designations have been the subject of many long and arduous battles through the years. Standardization in the inch series has come through many channels, but the present unified thread form could be considered to be the standard for many threaded products, particularly high strength ones such as socket head cap screws, etc. In common usage in U.S.A., Canada and United Kingdom are the Unified National Radius Coarse series, designated UNRC, Unified National Radius Fine series, designated UNRF, and several special series of various types, designated UNS. This thread, UNRC or UNRF, is designated by specifying the diameter and threads per inch along with the suffix indicating the thread series, such as 1/4 - 28 UNRF. For threads in Metric units, a similar approach is used, but with some slight variations. A diameter and pitch are used to designate the series, as in the Inch system, with modifications as follows: For coarse threads, only the prefix M and the diameter are necessary, but for fine threads, the pitch is shown as a suffix. For example, M16 is a coarse thread designation representing a diameter of 16 mm with a pitch of 2 mm understood. A similar fine thread part would be M16 x 1.5 or 16 mm diameter with a pitch of 1.5 mm.

For someone who has been using the Inch system, there are a couple of differences that can be a little confusing. In the Inch series, while we refer to threads per inch as pitch; actually the number of threads is 1/pitch. Fine threads are referenced by a larger number than coarse threads because they "fit" more threads per inch.

In Metric series, the diameters are in millimeters, but the pitch is really the pitch. Consequently the coarse thread has the large number. The most common metric thread is the coarse thread and falls generally between the inch coarse and fine series for a comparable diameter.

Also to be considered in defining threads is the tolerance and class of fit to which they are made. The International Standards Organization (ISO) metric system provides for this designation by adding letters and numbers in a certain sequence to the callout. For instance, a thread designated as M5 x 0.8 4g6g would define a thread of 5 mm diameter, 0.8 mm pitch, with a pitch diameter tolerance grade 6 and allowance "g". These tolerances and fields are defined as shown below, similar to the Federal Standard H28 handbook, which defines all of the dimensions and tolerances for a thread in the inch series. The callout above is similar to a designation class 3A fit, and has a like connotation.

COMPLETE DESIGNATIONS

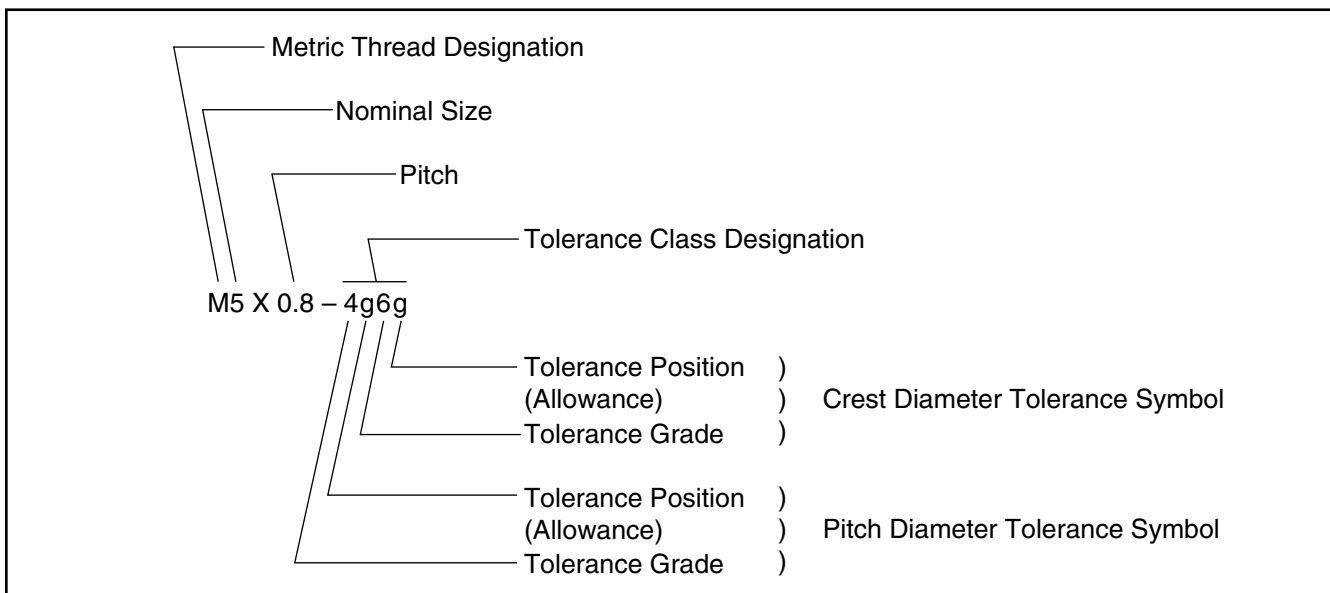

METRIC THREADS

Example of thread tolerance positions and magnitudes.
 Comparison 5/16 UNC and M8. Medium tolerance grades – Pitch diameter.

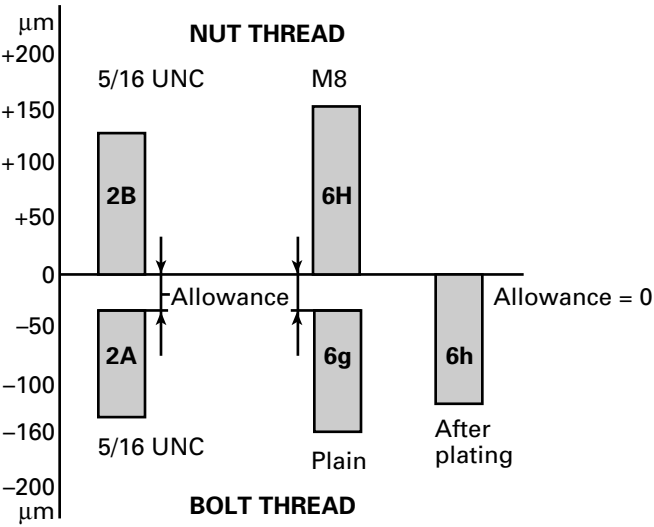

DEVIATIONS

external	internal	basic clearance
h	H	none
g	G	small
e		large

NOTE:
 Lower case letters = external threads
 Capital letters = internal threads

THROUGH-HOLE PREPARATION

DRILL AND COUNTERBORE SIZES FOR INCH SOCKET HEAD CAP SCREWS

Note 1

Close Fit: Normally limited to holes for those lengths of screws threaded to the head in assemblies in which: (1) only one screw is used; or (2) two or more screws are used and the mating holes are produced at assembly or by matched and coordinated tooling.

Note 2

Normal Fit: Intended for: (1) screws of relatively long length; or (2) assemblies that involve two or more screws and where the mating holes are produced by conventional tolerancing methods. It provides for the maximum allowable eccentricity of the longest standard screws and for certain deviations in the parts being fastened, such as deviations in hole straightness; angularity between the axis of the tapped hole and that of the hole for the shank; differences in center distances of the mating holes and other deviations.

Note 3

Chamfering: It is considered good practice to chamfer or break the edges of holes that are smaller than "F" maximum in parts in which hardness approaches, equals or exceeds the screw hardness. If holes are not chamfered, the heads may not seat properly or the sharp edges may deform the fillets on the screws, making them susceptible to fatigue in applications that involve dynamic loading. The chamfers, however, should not be larger than needed to ensure that the heads seat properly or that the fillet on the screw is not deformed. Normally, the chamfers do not need to exceed "F" maximum. Chamfers exceeding these values reduce the effective bearing area and introduce the possibility of indentation when the parts fastened are softer than screws, or the possibility of brinelling of the heads of the screws when the parts are harder than the screws. (See "F" page 6).

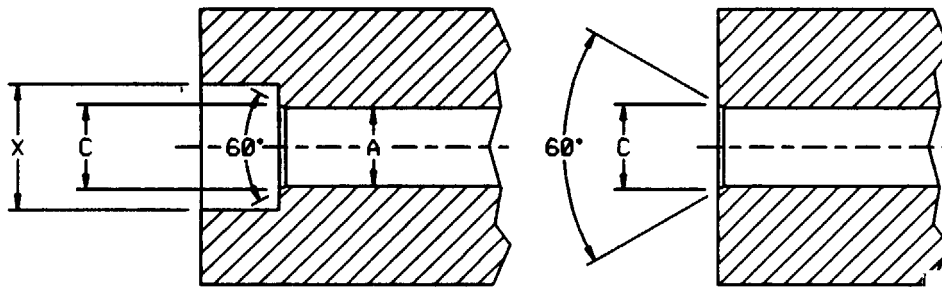

nominal size	basic screw diameter	A				X	C	hole dimensions					
		drill size for hole A						counter-bore diameter	countersink diameter D Max. + 2F(Max.)	tap drill size		**body drill size	counter-bore size
		close fit		normal fit						UNRC	UNRF		
		nom.	dec.	nom.	dec.								
0	0.0600	51*	0.0670	49*	0.0730	1/8	0.074	-	3/64	#51	1/8		
1	0.0730	46*	0.0810	43*	0.0890	5/32	0.087	1.5mm	#53	#46	5/32		
2	0.0860	3/32	0.0937	36*	0.1065	3/16	0.102	#50	#50	3/32	3/16		
3	0.0990	36*	0.1065	31*	0.1200	7/32	0.115	#47	#45	#36	7/32		
4	0.1120	1/8	0.1250	29*	0.1360	7/32	0.130	#43	#42	1/8	7/32		
5	0.1250	9/64	0.1406	23*	0.1540	1/4	0.145	#38	#38	9/64	1/4		
6	0.1380	23*	0.1540	18*	0.1695	9/32	0.158	#36	#33	#23	9/32		
8	0.1640	15*	0.1800	10	0.1935	5/16	0.188	#29	#29	#15	5/16		
10	0.1900	5*	0.2055	2*	0.2210	3/8	0.218	#25	#21	#5	3/8		
1/4	0.2500	17/64	0.2656	9/23	0.2812	7/16	0.278	#7	#3	17/64	7/16		
5/16	0.3125	21/64	0.3281	11/32	0.3437	17/32	0.346	F	I	21/64	17/32		
3/8	0.3750	25/64	0.3906	13/32	0.4062	5/8	0.415	5/16	Q	25/64	5/8		
7/16	0.4375	29/64	0.4531	15/32	0.4687	23/32	0.483	U	25/64	29/64	23/32		
1/2	0.5000	33/64	0.5156	17/32	0.5312	13/16	0.552	27/64	29/64	33/64	13/16		
5/8	0.6250	41/64	0.6406	21/32	0.6562	1	0.689	35/64	14.5mm	41/64	1		
3/4	0.7500	49/64	0.7656	25/32	0.7812	1-3/16	0.828	21/32	11/16	49/64	1-3/16		
7/8	0.8750	57/64	0.8906	29/32	0.9062	1-3/8	0.963	49/64	20.5mm	57/64	1-3/8		
1	1.0000	1-1/64	1.0156	1-1/32	1.0312	1-5/8	1.100	7/8	59/64	1-1/64	1-5/8		
1-1/4	1.2500	1-9/32	1.2812	1-5/16	1.3125	2	1.370	1-7/64	1-11/64	1-9/32	2		
1-1/2	1.5000	1-17/32	1.5312	1-9/16	1.5625	2-3/8	1.640	34mm	36mm	1-17/32	2-3/8		

** Break edge of body drill hole to clear screw fillet.

DRILL AND COUNTERBORE SIZES

DRILL AND COUNTERBORE SIZES FOR METRIC SOCKET HEAD CAP SCREWS

Note 1

Close Fit: Normally limited to holes for those lengths of screws threaded to the head in assemblies in which: (1) only one screw is used; or (2) two or more screws are used and the mating holes are produced at assembly or by matched and coordinated tooling.

Note 2

Normal Fit: Intended for: (1) screws of relatively long length; or (2) assemblies that involve two or more screws and where the mating holes are produced by conventional tolerancing methods. It provides for the maximum allowable eccentricity of the longest standard screws and for certain deviations in the parts being fastened, such as deviations in hole straightness; angularity between the axis of the tapped hole and that of the hole for the shank; differences in center distances of the mating holes and other deviations.

Note 3

Chamfering: It is considered good practice to chamfer or break the edges of holes that are smaller than "B" maximum in parts in which hardness approaches, equals or exceeds the screw hardness. If holes are not chamfered, the heads may not seat properly or the sharp edges may deform the fillets on the screws, making them susceptible to fatigue in applications that involve dynamic loading. The chamfers, however, should not be larger than needed to ensure that the heads seat properly or that the fillet on the screw is not deformed. Normally, the chamfers do not need to exceed "B" maximum. Chamfers exceeding these values reduce the effective bearing area and introduce the possibility of indentation when the parts fastened are softer than screws, or the possibility of brinelling of the heads of the screws when the parts are harder than the screws.

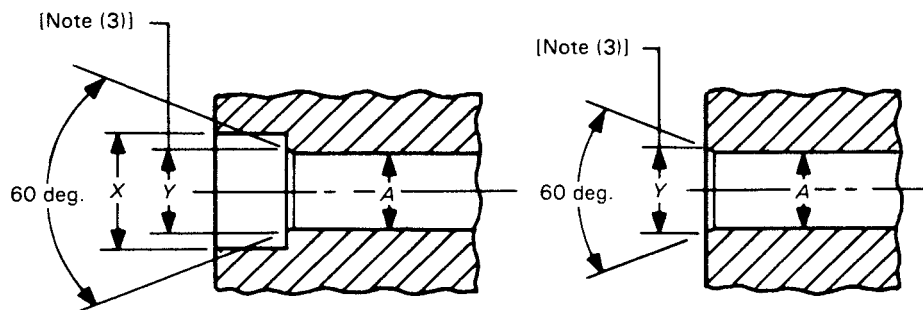

Nominal Size or Basic Screw Diameter	A		X	Y	B
	Nominal Drill Size		Counterbore Diameter	Countersink Diameter [Note (3)]	Transition Diameter, Max.
	Close Fit [Note (1)]	Normal Fit [Note (2)]			
M1.6	1.80	1.95	3.50	2.0	2.0
M2	2.20	2.40	4.40	2.6	2.6
M2.5	2.70	3.00	5.40	3.1	3.1
M3	3.40	3.70	6.50	3.6	3.6
M4	4.40	4.80	8.25	4.7	4.7
M5	5.40	5.80	9.75	5.7	5.7
M6	6.40	6.80	11.25	6.8	6.8
M8	8.40	8.80	14.25	9.2	9.2
M10	10.50	10.80	17.25	11.2	11.2
M12	12.50	12.80	19.25	14.2	14.2
M14	14.50	14.75	22.25	16.2	16.2
M16	16.50	16.75	25.50	18.2	18.2
M20	20.50	20.75	31.50	22.4	22.4
M24	24.50	24.75	37.50	26.4	26.4
M30	30.75	31.75	47.50	33.4	33.4
M36	37.00	37.50	56.50	39.4	39.4
M42	43.00	44.0	66.00	45.6	45.6
M48	49.00	50.00	75.00	52.6	52.6

HARDNESS – TENSILE CONVERSION

INCH ROCKWELL – BRINELL – TENSILE CONVERSION

Rockwell "C" scale	Brinell hardness number	tensile strength approx. 1000 psi
60	654	336
59	634	328
58	615	319
57	595	310
56	577	301
55	560	292
54	543	283
53	524	274
52	512	265
51	500	257
50	488	249
49	476	241
48	464	233
47	453	225
46	442	219
45	430	212
44	419	206

Rockwell "C" scale	Brinell hardness number	tensile strength approx. 1000 psi
43	408	200
42	398	194
41	387	188
40	377	181
39	367	176
38	357	170
37	347	165
36	337	160
35	327	155
34	318	150
33	309	147
32	301	142
31	294	139
30	285	136
29	279	132
28	272	129
27	265	126

Rockwell		Brinell hardness number	tensile strength approx. 1000 psi
"C" scale	"B" scale		
26		259	123
25		253	120
24		247	118
23		241	115
22	100	235	112
21	99	230	110
20	98	225	107
(19)		220	104
(18)	97	215	103
(17)		210	102
(16)	96	206	100
(15)		201	99
(14)	95	197	97
(13)	94	193	96
(12)	93	190	93
(11)		186	91
(10)	92	183	90

METRIC ROCKWELL – BRINELL – TENSILE CONVERSION

Rockwell "C" scale	Brinell hardness number	tensile strength approx. MPa
60	654	2,317
59	634	2,261
58	615	2,199
57	595	2,137
56	577	2,075
55	560	2,013
54	543	1,951
53	524	1,889
52	512	1,827
51	500	1,772
50	488	1,717
49	476	1,662
48	464	1,606
47	453	1,551
46	442	1,510
45	430	1,462
44	419	1,420

Rockwell "C" scale	Brinell hardness number	tensile strength approx. MPa
43	408	1,379
42	398	1,338
41	387	1,296
40	377	1,248
39	367	1,213
38	357	1,172
37	347	1,138
36	337	1,103
35	327	1,069
34	318	1,034
33	309	1,014
32	301	979
31	294	958
30	285	938
29	279	910
28	272	889
27	265	869

Rockwell		Brinell hardness number	tensile strength approx. MPa
"C" scale	"B" scale		
26		259	848
25		253	827
24		247	814
23		241	793
22	100	235	772
21	99	230	758
20	98	225	738
(19)		220	717
(18)	97	215	710
(17)		210	703
(16)	96	206	690
(15)		201	683
(14)	95	197	669
(13)	94	193	662
(12)	93	190	641
(11)		186	627
(10)	92	183	621

THREAD STRESS AREAS

Inch and Metric

STRESS AREAS FOR THREADED FASTENERS – INCH

Diameter (in.)		Diameter (mm)	Threads Per in.		Square Inches		
					Tensile Stress Area Per H-28		Nominal Shank
			UNRC	UNRF	UNRC	UNRF	
#0	0.06	1.52	–	80	–	0.00180	0.002827
#1	0.07	1.85	64	72	0.00263	0.00278	0.004185
#2	0.09	2.18	56	64	0.00370	0.00394	0.005809
#3	0.10	2.51	48	56	0.00487	0.00523	0.007698
#4	0.11	2.84	40	48	0.00604	0.00661	0.009852
#5	0.13	3.18	40	44	0.00796	0.00830	0.012272
#6	0.14	3.51	32	40	0.00909	0.01015	0.014957
#8	0.16	4.17	32	36	0.0140	0.01474	0.021124
#10	0.19	4.83	24	32	0.0175	0.0200	0.028353
1/4	0.25	6.35	20	28	0.0318	0.0364	0.049087
5/16	0.31	7.94	18	24	0.0524	0.0580	0.076699
3/8	0.38	9.53	16	24	0.0775	0.0878	0.11045
7/16	0.44	11.11	14	20	0.1063	0.1187	0.15033
1/2	0.50	12.70	13	20	0.1419	0.1599	0.19635
9/16	0.56	14.29	12	18	0.182	0.203	0.25
5/8	0.63	15.88	11	18	0.226	0.256	0.31
3/4	0.75	19.05	10	16	0.334	0.373	0.44179
7/8	0.88	22.23	9	14	0.462	0.509	0.60132
1	1.00	25.40	8	12	0.606	0.663	0.79
1-1/8	1.13	28.58	7	12	0.763	0.856	0.99402
1-1/4	1.25	31.75	7	12	0.969	1.073	1.2272
1-3/8	1.38	34.93	6	12	1.155	1.315	1.4849
1-1/2	1.50	38.10	6	12	1.405	1.581	1.7671
1-3/4	1.75	44.45	5	12	1.90	2.19	2.4053
2	2.00	50.80	4-1/2	12	2.50	2.89	3.1416
2-1/4	2.25	57.15	4-1/2	12	3.25	3.69	3.9761
2-1/2	2.50	63.50	4	12	4.00	4.60	4.9088
2-3/4	2.75	69.85	4	12	4.93	5.59	5.9396
3	3.00	76.20	4	12	5.97	6.69	7.0686

STRESS AREAS FOR THREADED FASTENERS – METRIC

Nominal Dia. Thread and Pitch (mm)	Thread Tensile Stress Area (mm ²)	Nominal Shank Area (mm ²)
1.6 x 0.35	1.27	2.01
2.0 x 0.4	2.07	3.14
2.5 x 0.45	3.39	4.91
3.0 x 0.5	5.03	7.07
4.0 x 0.7	8.78	12.6
5.0 x 0.8	14.2	19.6
6.0 x 1	20.1	28.3
8.0 x 1.25	36.6	50.3
10 x 1.5	58.00	78.5
12 x 1.75	84.3	113
14 x 2	115	154
16 x 2	157	201

Nominal Dia. Thread and Pitch (mm)	Thread Tensile Stress Area (mm ²)	Nominal Shank Area (mm ²)
18 x 2.5	192	254
20 x 2.5	245	314
22 x 2.5	303	380
24 x 3	353	452
27 x 3	459	573
30 x 3.5	561	707
33 x 3.5	694	855
36 x 4	817	1018
42 x 4.5	1120	1385
48 x 5	1470	1810

ENGINEERING PART NUMBERS – INCH

Unbrako provides a stock number for every standard, stocked item in its price list. However, there may be particular sizes or optional features the user may desire. The following part numbering system allows the engineer or designer to record a particular description for ordering.

Alloy Steel	Drilled Head (3)	#4	UNRC	1 1/2"	Cadmium Plate
20097	H3	-94	C	-24	C

FINISH

B – Chemical Black Oxide S – Silver Plate
 C – Cadmium Plate – Silver U – Zinc Plate – Silver
 D – Cadmium Plate – Yellow Z – Zinc Plate – Yellow

No letter indicates standard black finish (Thermal Oxide) for alloy steel and passivation for stainless steel.

LENGTH in 16ths

THREAD TYPE C – coarse, F – fine

DIAMETER*

DIA.	#0	#1	#2	#3	#4	#5	#6	#8	#10	1/4	5/16	3/8	7/16	1/2	9/16
DASH NO.	90	91	92	93	94	95	96	98	3	4	5	6	7	8	9

DIA.	5/8	3/4	7/8	1	1 1/8	1 1/4	1 3/8	1 1/2	1 3/4	2	2 1/4	2 1/2	2 3/4	3
DASH NO.	10	12	14	16	18	20	22	24	28	32	36	40	44	48

OPTIONAL FEATURES

Cross Drilled Heads: Self-Locking:
 H1 – 1 Hole Thru E – LOC-WEL to MIL-DTL18240
 H2 – 2 Hole2 Thru L – LOC-WEL (Commercial)
 H3 – 3 Holes Thru P – Nylon Plug
 TF – TRU-FLEX
 K – Nylon Plug to MIL-DTL18240

BASE NUMBER

20097 – socket head cap screw – alloy steel
 20098 – socket head cap screw – stainless steel
 72531 – low head cap screw
 12705 – shoulder screw
 16990 – flat head cap screw – alloy steel
 16991 – flat head cap screw – stainless steel
 38030 – button head cap screw – alloy
 38031 – button head cap screw – stainless steel
 05455 – square head cap screw – knurled cup
 05456 – square head cap screw – half dog

Set Screws

Alloy Steel	Stainless Steel	
28700	28707	flat point
28701	28708	cup point
28704	28709	knurled cup point
28702	28710	cone point
28705	28711	oval point
28706	28713	half dog point

* Shoulder screws are designated by shoulder diameter

OPTIONAL PART NUMBERING SYSTEM

PRESSURE PLUG PART NUMBERS

Basic Part No.	Material	1/4"	Finish
29466	A	-4	C

FINISH
 B – Chemical Black Oxide
 C – Cadmium Plate-Silver
 D – Cadmium Plate-Yellow
 S – Silver Plate
 U – Zinc Plate – Silver
 Z – Zinc Plate – Yellow

NOMINAL SIZE IN 16ths

OPTIONAL FEATURES

A – Austenitic Stainless
 D – Aluminum
 E – Brass
 No letter – alloy steel

BASIC PART NUMBER

29466 – dry seal
 *38194 – LEVEL-SEAL
 **69188 – PTFE/TEFLON coated

* Standard stock available in austenitic stainless steel, brass, and alloy only

** Standard stock available in austenitic stainless steel, and alloy only

DOWEL PINS PART NUMBERS

The Part number consists of (1) a basic part number describing the item; (2) a dash number and letter designating diameter and oversize dimension; (3) a dash number designating length.

dowel pin	1/4"	.001 oversize	1/2"
28420	-250	B	-8

LENGTH in 16ths

OVERSIZE A-.0002, B-.001, C-.002 (see below)

DIAMETER in thousandths

BASIC PART NUMBER

28420 – Standard Dowel Pins
 69382 – Pull-Out Dowel Pins

HEX KEYS PART NUMBERS

The Part number consists of (1) a basic part number describing the item; (2) a dash number designating size and a letter denoting finish.

long arm	1/4"
05854	-13

FINISH Standard Black Finish (Thermal Oxide)

See dash number in dimension table page 32

BASIC PART NUMBER

05853 – short arm wrench
 05854 – long arm wrench
 78950-6" – long arm wrench

ENGINEERING PART NUMBERS – METRIC

Alloy Steel	Drilled Head (3)	4MM Dia.	Thread Pitch	Length	Cadmium Plate
76000	H3	-M4	-0.7	-12	C

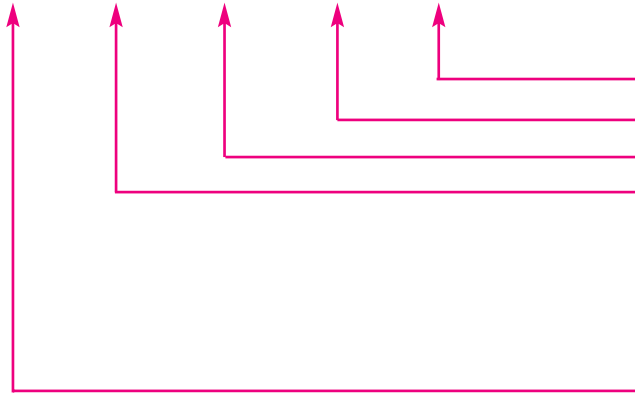

FINISH

B – Chemical Black Oxide S – Silver Plate
 C – Cadmium Plate – Silver U – Zinc Plate – Silver
 D – Cadmium Plate – Yellow Z – Zinc Plate – Yellow

No letter indicates standard black finish (Thermal Oxide) for alloy steel and passivation for stainless steel.

LENGTH in mm

THREAD TYPE STATE THREAD PITCH

DIAMETER in mm*

OPTIONAL FEATURES

Cross Drilled Heads: Self-Locking:
 H1 – 1 Hole Thru E – LOC-WEL to MIL-DTL-18240
 H2 – 2 Hole2 Thru L – LOC-WEL (Commercial)
 H3 – 3 Holes Thru P – Nylon Plug
 TF – TRU-FLEX
 K – Nylon Plug to MIL-DTL-18240

BASE NUMBER

76000 – metric socket head cap screw – alloy steel
 76001 – metric socket head cap screw – stainless steel
 76002 – metric low head cap screw – alloy
 76032 – metric low head cap screw – stainless steel
 76005 – metric flat head cap screw – alloy steel
 76006 – metric flat head cap screw – stainless steel
 76003 – metric button head cap screw – alloy
 76004 – metric button head cap screw – stainless steel
 76007 – metric shoulder screw – alloy

Metric Set Screws

Alloy Steel	Stainless Steel	
76010	76016	flat point
76011	76017	cup point
76012	76018	knurled cup point
76013	76019	cone point
76014	76020	oval point
76015	76021	half dog point

* Shoulder screws are designated by shoulder diameter

HEX KEYS PART NUMBERS (METRIC)

The Part number consists of (1) a basic part number describing the item; (2) a dash number designating size.

long arm	5mm
76023	5

FINISH Standard Black Finish (Thermal Oxide)

Key size in mm

BASIC PART NUMBER | 76022 – short arm wrench
76023 – long arm wrench

DOWEL PINS PART NUMBERS (METRIC)

The Part number consists of (1) a basic part number describing the item; (2) a dash number and letter designating diameter and oversize dimension; (3) a dash number designating length.

dowel pin	6mm	.0275 oversize	8mm
76024	-6	B	-8

LENGTH in mm

OVERSIZE A-.0055, B-.0275mm

DIAMETER in mm

BASIC PART NUMBER | 76024 – Standard Dowel Pins
76035 – Pull-Out Dowel Pins



Advantages built into every detail.

THE UNBRAKO DIFFERENCE
Your application demands a fastener which outperforms all others. We build our products for life, to help you build your products for life.

What's holding your product together?

**CALL FOR A
SAMPLE
AND EXPERIENCE
THE UNBRAKO
DIFFERENCE FOR
YOURSELF.**

HIGHER MIN ULT TENSILE
10,000 PSI stronger than industry standard
COMPOUND FILLET RADIUS
Doubles fatigue life at critical head-shank juncture
WIDE RADIUS THREADS
Maximizes fatigue resistance where it's needed most
3R (RADIUSED ROOT RUNOUT) THREAD
Increases fatigue life up to 300%
E CODE "LOT CODE" MARKINGS
The ultimate in fastener traceability

Unbrako[®]
BUILT FOR LIFE.

DEEPAK FASTENERS (EUROPE)
Deepak Fasteners (Shannon) Ltd.
BAYS 25-30, Shannon Industrial Estate
County Clare, IRELAND

Ph: +353 - 61 - 716 - 500
Fax: +353 - 61 - 716 - 584
sales@deepakfasteners.com

DEEPAK FASTENERS (UK)
Deepak Fasteners (U.K) Ltd.
12-14 TOWER STREET, Newtown,
BIRMINGHAM (U.K.), B19 3RR

Ph: +44-121-333-4610
Fax: +44-121-333-4525
sales@deepakfasteners.com

DEEPAK FASTENERS (INDIA)
Deepak Fasteners Ltd.
4th Floor, First Mall, The Mall
Ludhiana-141001 (PB.) INDIA

Ph: +91 - 161 - 3911111
Fax: +91 - 161 - 2774400
sales@deepakfasteners.com

DEEPAK FASTENERS (AUSTRALIA)
Deepak Fasteners (Australia) Pty Ltd.
67 - 69 Licola South,
Dandenong - 3175, AUSTRALIA

Ph: +61 - 3 - 98940026
Fax: +61 - 3 - 98940038
sales@deepakfasteners.com

DEEPAK FASTENERS (USA)
INTERFAST Miami
12400 SW 134th Court
Miami Florida 33186 USA

Ph: +1 - 877 - 669 - 9024
Fax: +1 - 800 - 225 - 5777
sales@deepakfasteners.com